

THE ARUP JOURNAL

SHABANI SPECIAL ISSUE

1981

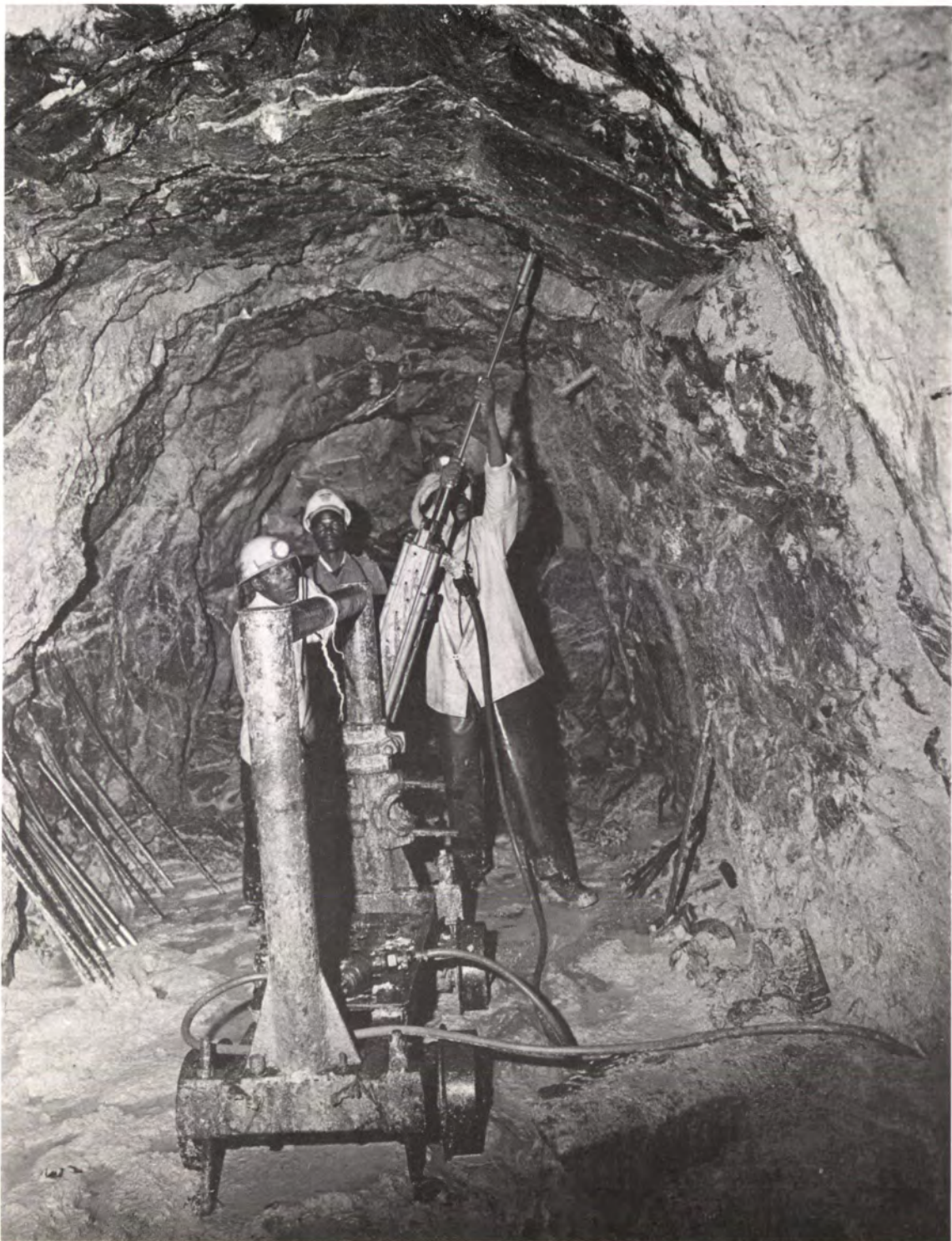

THE ARUP JOURNAL

Vol. 16 Shabani special issue 1981
Published by
Ove Arup Partnership
13 Fitzroy Street, London W1P 6BQ

Editor: Peter Hoggett
Art Editor: Desmond Wyeth FSIAD
Assistant Editor: David Brown

Front cover: Underground workings—shot holes being prepared (Photo: Bob Davey)
Back cover: Conical tower, Great Zimbabwe

Design of a new asbestos mill in Shabani, Zimbabwe

Introduction

Shabani and Mashaba Mines (Private) Ltd. have recently completed the construction of one of the world's biggest and most modern asbestos mills in Shabani, Zimbabwe, at a cost in excess of Z\$100m. (Fig. 1). The monthly milling capacity of the new mill is designed to be 200,000 tonnes of ore. Shabani has the largest reserves of asbestos fibre in Southern Africa. The deposit occurs near the base of a lenticular ultrabasic sill 14.5km long and 2.4 to 4.8km wide, which intrudes early Pre-Cambrian gneisses. The quality is good and the length of fibre is up to 30mm in places.

The design and construction was controlled by African Associated Mines (Private) Ltd., Secretaries and Consulting Engineers to Shabani and Mashaba Mines (Private) Ltd. Ove Arup and Partners provided an 'arms and legs' service to AAM by supplying the engineering skills that were lacking in their own organization. In broad terms AAM carried out the design of the plant and the mechanical equipment while Arups handled the civil, structural and electrical aspects. Programming and cost control were handled jointly. Fig. 2 shows diagrammatically the breakdown of work into the various disciplines. This paper briefly describes Arups' work, which was completed at a cost of approximately Z\$43m.

The process

The extraction of asbestos fibre from ore is a lengthy and complicated process which varies between different ore bodies. At Shabani, the ore is mined at various levels down to a depth of about 570m.

2 The mill has two basic sections; the feed

system (Figs. 3, 4 and 5) and the treatment plant. In the feed system, the ore is taken from the wet ore stockpiles (Fig. 6) and is crushed, screened, dried and fed into the dry ore stockpile. From these stockpiles, the ore is carried on conveyor belts to the top of the treatment plant. It then gravitates down through a series of screens where the fibre is separated from the rock and is carried in a current of air to cyclones, where it is deposited. The rock residue is treated in fibreizers and screened again to separate out the shorter fibres.

After a succession of similar processes, the rock, by now a fine sand, is sent to a discard dump. The separated fibre in the cyclone is cleaned to remove dust and grit, graded by length, and opened to the required degree. It is then blended to specification and bagged ready for shipment.

The process design for the removal of the asbestos fibre from the ore is an art based on years of experimentation and experience. Testing of prototype items of plant was carried out throughout the design period. The final structural design and production of reinforcing schedules goes from the foundations upwards, i.e. in the opposite direction to the mechanical design. As the various designs were developed simultaneously, a structural system which could accept changes was required. The electrical design developed alongside the mechanical and had to be able to accept additional loads as the process was refined.

Historical development

A similar mill, at King Mine, roughly two thirds the size of the one at Shabani, was built at Mashaba, 40km away, 10 years earlier by the same group. The design of the King Mine treatment plant was based on a vertical flow of materials through the reduction process rather than the horizontal flow previously adopted by this group. This concept proved successful and was repeated at Shabani. It obviously radically changes

the structural concept and gives rise to a new form of treatment plant.

Prior to the commencement of design of the King Mill, it was assumed that the building would follow tradition and have a steel frame with reinforced concrete infill floors. Arups were commissioned to carry out the structural design. Together with AAM, they decided to use a solid flat slab concrete solution. This decision was based mainly on economic considerations and it has other advantages. All necessary skills and materials for the construction of concrete structures are available throughout Zimbabwe, while the majority of steelwork for large structures requires the expenditure of foreign currency for supply and erection. The comfort and safety of the workers within the plant is of major concern, and an all-concrete structure provides fewer crevices for dust and is easier to wash down. Delays in supplies of structural steelwork are always a serious disadvantage.

A possible disadvantage of a concrete solution is in reduced flexibility for change once the structure is complete. This problem was solved, in effect, by overdesigning by an agreed margin to allow for changes. From the experience gained on the Mashaba Project as well as from other similar jobs, the concrete solution was further developed at Shabani to provide not only the structural frame, but also in places, a part of the plant.

In order to be successful, the total plant, including the construction, operation and maintenance, had to be conceived as a whole. Environmental conditions within the plant, comfort and safety of staff, maintenance costs, including those for down time, and availability of skilled labour, were among the features considered during the design. The text draws attention to certain of these aspects.

Civil design

The civil engineering works which were broken down into a number of contracts included upgrading existing services and

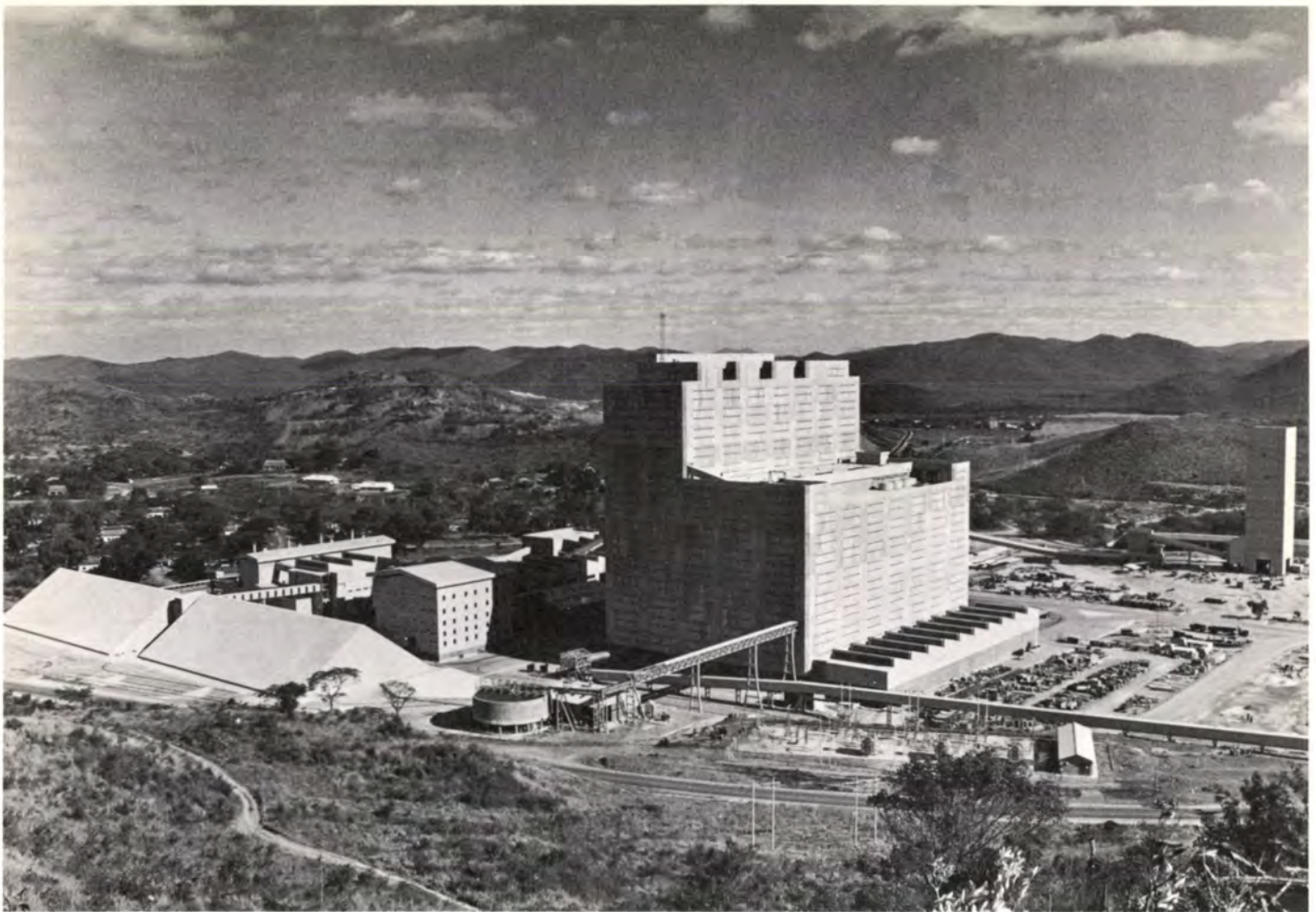

Fig. 1
General view of completed project

Fig. 2
Breakdown of work into various disciplines

Fig. 3
Feed system : dryer building,
showing top of vertical dryer

Fig. 4
Feed system : wet pick-up building,
showing Q-deck dryer

Fig. 5
Feed system : screening plant
typical floor

Fig. 6
Site surfacing and feed system :
wet ore stockpile

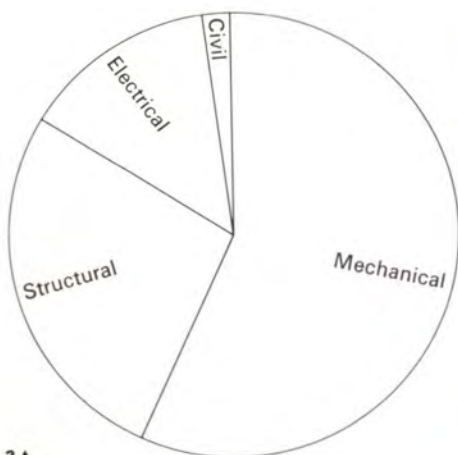
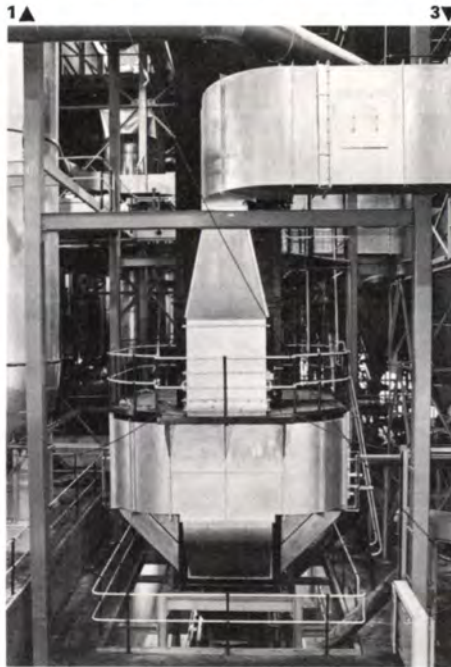

providing new facilities. This work was carried out in the period August 1976 to June 1980 at a total cost of around Z\$4m. Of this, Z\$2m. were part of the main project while Z\$2m. were for projects off-site.

Off-site housing

The decision to establish the new asbestos mill at Shabani gave rise to an immediate requirement for additional housing on the site. Traditionally the mine has provided housing for all its workers. The short-term need was to provide housing to replace that lost on the mill site and for the influx of construction workers required to complete the project, with a longer term requirement for the additional mine workers necessary to cope with the increased production. The housing required was in three grades, with requirements of 60 high cost units, 200 medium cost units and 400 low cost units. The low cost and some of the high cost units were located in an infill pattern in existing townships on the mine, with the other units in new township areas.

Ove Arup and Partners carried out the planning for the housing and the civil engineering design for water and sewerage reticulations, roads, stormwater drainage and electrical reticulations. All housing units had individual connections to water supply, sewerage reticulation and electricity, thereby breaking away from the tradition on the mine for communal facilities for low-cost housing. Street lighting was provided in all housing areas. The services design maximized the use of locally available material with asbestos cement piping being used extensively for water and sewerage reticulations and locally available gravel for road construction. Fig. 7 shows an area of completed high cost housing.

Diversion of services

The site chosen for the new mill was an area previously used for low density housing and included, on the eastern boundary, the national road from Shabani to Buchwa. All the houses in the area were to be demolished but certain services, serving areas outside the limits of the mill site, ran through the area. Before bulk earthworks could commence, all these through services had to be diverted and the national road moved beyond the confines of the site. The planning of the mill complex was in its early stages at this time and conservative estimates had to be made of the likely extent of the mill site.

The diversion of the Buchwa road comprised a length of approximately 800m over some difficult terrain. The cross-section of the road was the Government standard for this class of road of 7m of surface on a 10m base course. Geometric standards laid down by the Government for national roads were complied with, in spite of the fact that at the present, it is a gravel road on a very poor alignment, approximately 2km from Shabani. The main pipe services crossing the mill site consisted of a sewage pumping main, potable and industrial water supply mains and a return sewage effluent main. Plans had already commenced for an upgrading of all these services and the immediate need was therefore a short-term temporary diversion around the site. The four pipelines were laid adjacent to each other in a single trench with minimal cover around the western and northern boundaries of the site.

Water supply

The water supply to Shabani came from the Lundi River. At the time of the start of the mill project, work was already under way on the design and construction of a new dam on the Ngezi River to supply Shabani with water. In view of this, we were asked to investigate the water reticulation on the mine, and to report on it. The entire mine complex is supplied with a dual reticulation supplying



Fig. 7
Area of completed high cost housing

Fig. 8
Sewage pumping station

7 ▲ 8 ▼



both potable and industrial water. The industrial water is recovered from the underground workings and is used in the process and for garden watering. All water used on the mine is supplied free of charge to the mine personnel, and the *per capita* consumptions are therefore enormous. Our report envisaged a rationalization of the main water reticulation to cater for the projected increase in population and the raising of living standards of the lower paid workers. The philosophy of bulk water storage on the mine was also examined and reported on.

As a result of this report we were commissioned to implement the first part of the recommendations which consisted of a 12,000m³ storage reservoir and 2.5km of supply pipeline. The reservoir, of reinforced concrete, was constructed on a hill overlooking the new mill site and positioned to allow for the construction of two future reservoirs of similar size, as the demand required. The pipeline, which was 450mm diameter asbestos cement, supplied water to the reservoir from the main pump station at which the Ngezi water supply was received.

Sewerage reticulation

Simultaneously with the appointment to investigate the overall water reticulation of the mine, we were appointed to produce a similar report for the overall sewerage reticulation. The terrain of Shabani is made up of numerous small hills with housing areas generally located in the valleys between. Very limited use can therefore be made of gravity sewerage. A complex of sewerage pumping stations existed over the mine with several of these obviously overloaded. Our report recommended the rationalization and upgrading of the pumped sewerage system as a phased development. The upgrading and re-siting of one of the pump stations serving the low-cost housing areas had already been required as a result of the extension of the low-cost housing, and this, together with a secondary pump station pumping into it and a

delivery main to the treatment works, had been included in our brief for the housing services. The next phase for which we were appointed was the design of the necessary upgrading of the system serving the southern part of the mine. This consisted of four pump stations and approximately 4km of pumping main, and 4km of gravity sewers.

The pumping stations were all designed as identical underground structures with submersible pumps. Allowance was made in the design for increasing the number of pumps and duplicating the delivery mains when required, so that ultimately the system would cope with the flows anticipated in 1995. Fig. 8 shows a typical pump station with inlet works for grit removal.

The mill site

The civil engineering on the mill site was carried out in four stages. The first of these was the bulk earthworks. Prior to construction, the site consisted of fairly rough, tree covered terrain with a maximum fall across it of the order of 12m and a natural water course through the centre. Because the planning of the feed system would not be completed until some time after the commencement of construction of the treatment plant it was necessary to provide an earthwork solution that allowed flexibility in the planning. It was therefore decided to provide a cut and fill platform over the entire site. This platform was generally graded to falls of 1:100 to permit drainage of the surface. The water course was diverted around the southern extremity of the mill site.

As the planning of the mill complex became more finalized it was possible to design the second stage of the civil works. This consisted of the sewerage reticulation for the site, and roads and stormwater drainage over the northern portion.

The third stage took the stormwater drainage a step further and provided temporary drainage in the areas not finalized. This was carried out prior to the 1978 rainy season.



Fig. 9
Secondary drain to south of treatment plant building

Fig. 10
Main drain through mill site

Fig. 11
Spillway from mill site

Fig. 12
Site surfacing



11▲ 12▼



9▲ 10▼



The fourth stage was the completion of the stormwater drainage, finalization of the site levelling, the roads, the surfacing of the site, the completion of the sewerage reticulation and the intersection of the main access road to the site with the Shabani to Buchwa road.

The stormwater drainage consists principally of open concrete lined drains (Fig. 9), piped or culverted. Underground stormwater drainage was avoided wherever possible, as the milling process produces large quantities of fibrous dust which, during Shabani's long dry season, could easily block invisible stormwater drainage routes. Two main drains ran through the site, one at the southern extremity carrying the water from the diverted water course as well as water from the southern portion of the site. The other main drain through the centre of the site picked up a small catchment outside the site and also drained the majority of the site (Fig. 10). At the western end of the site, where the central drain discharged, the bulk earthworks contract had raised the finished level some 8m above natural ground level. This required a spillway structure to take peak flow of approximately $11\text{m}^3/\text{sec}$. prior to passing it under the main mine hall road (Fig. 11).

The main access road into the site carries the finished product from the mill to the rail head for despatch. This was the only formal road on the site, and was a 7m surfaced road on a 10m base. The client's requirements for the remainder of the site were that vehicles should be able to drive anywhere without being impeded by stormwater drainage or other surfaces. This required that secondary drains on the site should be shallow 'dish' drains, permitting vehicles to cross. The entire 25ha site was therefore topped with a compacted gravel layer sealed with a single seal surface dressing. Within this, identifiable heavy traffic routes were demarcated, with double seal surfacing in these areas. Figs. 6 and 12 show some of the surfaced area with 'dish' drains.

Structural design

The total civil and structural engineering works on the mill site were completed for a cost of Z\$27.3m. The treatment plant represents 58% of the civil contract, the remaining buildings 34%, while the bulk earthworks, diversion of existing services, site roads, stormwater drainage, etc., make up the remaining 8%.

Building work on the treatment plant building commenced in October 1977 and was completed in December 1979, while the feed system was completed in May 1980. The total civil/structural work force peaked at 2,650 in February 1979.

Treatment plant

The main structural design effort was directed toward the treatment plant. This building rises 100.6m above the ground, and has a double basement to a depth of 5.5m. The total floor area is $138,000\text{m}^2$. The first main nine floors are $100.5 \times 76.5\text{m}$, stepped back at the ninth level up to the 16th floor. The upper main floors are $100.5 \times 33.0\text{m}$. Fig. 13 shows a section through the treatment plant. A typical main floor, which consists of four flow lines, a service bay and a perimeter conveyor corridor, is shown in Fig. 17.

Most of the plant is carried on the main floors. The column grid was selected to impose minimum restraints on the plant layout and at the same time, together with the box columns, provide a linear surface on which to attach crane rails, conveyor gantries and so on. Column sizes were constant for the entire building. Major floor openings, i.e. larger than 1.2m square, were decided before the slab was cast, while many minor openings were added after the reinforcing had been designed and detailed. Where possible, these were added before the concrete was cast, but in some cases were punched through the coffer topping afterwards. Approximately 80% of the openings, other than major openings common to all typical main floors,

fell within the coffer topping and could therefore be ignored in the design.

In each flow line there are three service ducts (box columns) which act as air plenums connecting the fan chambers to the various main floors. The box columns also act as vertical shafts to enclose electrical cables, stairs and other services. Openings are provided in the sides to allow access where required. The main floor to floor height is 6m.

Between the first and second floors and for 12 floors thereafter, hung floors are used for working platforms to the machinery on the main floors. All floors, including the hung floors, will be washed down while the plant is in operation and therefore openings are provided with upstand surrounds except the washdown outlets. As can be seen in Fig. 13, the hung floors cover only portions of the complete floor area. Many of the items of plant on one main floor are connected to the plant on the floor above or below by screw conveyors or chutes. The openings required in the hung floors are more numerous and often larger than in the main floors and would have made spanning between the main vertical supports difficult with a reasonable depth of slab. For this reason additional supports from the main floors were added. Hanging rather than propping the intermediate floors was decided upon to allow maximum working space above and around the plant on the main floors (Figs. 14, 15 and 16).

In order to maintain the rhythm of the construction programme simple standard elements were used to a maximum, although in some cases this was extravagant in terms of materials. Where it was no longer possible to use or justify the use of standard elements, conventional building techniques were used.

The main non-typical section of the treatment plant is the dust filter area, situated at the top of the low portion. This area houses 10 fans, two of which are on standby. The remaining eight provide $57,000\text{m}^3$ of air a minute for the plant. The air chambers operate at a negative 5

Fig. 13
Section through treatment plant

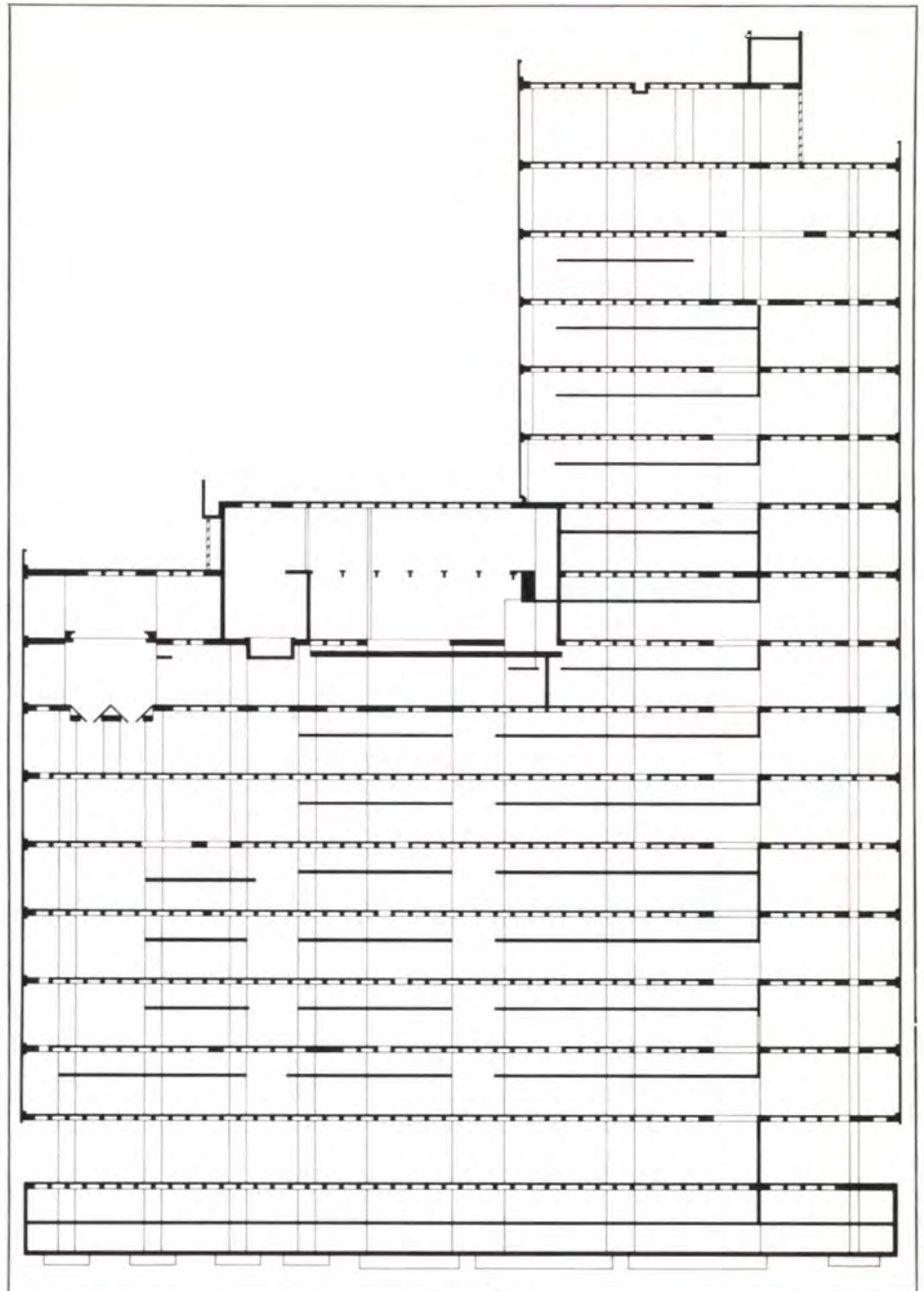

Fig. 14
Treatment plant : seventh
floor with equipment installed

Fig. 15
Treatment plant : typical main
and intermediate hung floor
with equipment installed

Fig. 16
Treatment plant : main floor
with cyclones projecting through
hung floor as above

13▲ 14▼

15▼

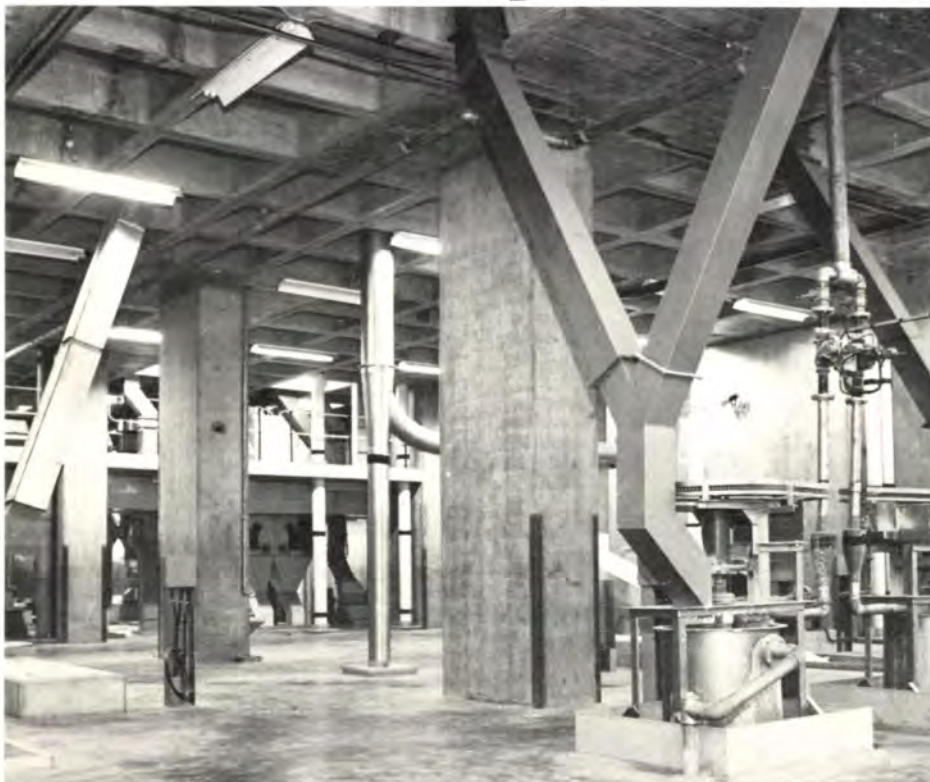

16▼



pressure of 375mm of water gauge. To save foreign currency the walls of the chambers are cast in situ concrete and the dust hoppers are precast concrete. The construction of the filter area and the high portion of the treatment plant building proceeded simultaneously. No expansion joints are provided in the treatment plant building except at roof levels, and then not for those areas over the filter chambers. The roofs over the filter chambers are insulated to reduce thermal movement. Additional reinforcement was added to cater for thermal and shrinkage strains.

The main reason for no joints was to avoid having to cater for movements in such mechanical equipment as screw conveyors, chutes, crane rails and so on.

Waterproofing of the filter chambers was particularly critical, as any water or air leakage would interfere with the process. Working downwards from the top the waterproofing medium was built as follows:

- (1) 450×450×40mm thick precast concrete slabs with 25mm open joints between slabs
- (2) 75mm sand/concrete cover slab in

2.85m square panels with soft board joints between panels

- (3) 1000 gauge polythene sheeting with double welt folds
- (4) 2mm thick waterproofing membrane of butyl rubber sheeting with zig-zag edges glued together on site
- (5) 25mm thick polyurethane insulation bonded to concrete
- (6) Surface of concrete or screed.

In less critical areas waterproofing consists of two layers of mastic asphalt layed on Kraft bituminous paper and covered with flat asbestos/cement roofing tiles.

A minimum of 1 in 80 falls was achieved either by tilting the slab, or by laying a screed to fall.

The six standard building elements used for the treatment plant building are itemized below. These were developed in close collaboration with the civil contractor whose practical experience was invaluable. Mock-ups of all the standard elements were made before the construction of the treatment plant commenced.

Main floors

These are of 1.5m square coffer construction with an overall depth of 0.5m (Fig. 18). They are designed for a superimposed load of 15.6kN/m² (main floor live load 6.0kN/m², hung floor live load+dead load 9.6kN/m²). They were also designed to have props removed after seven days and to carry a subsequent floor after 14 days. The design allows for additional openings up to 1.2m square to be added any time through the coffer topping. Cable routes were provided within the coffer depth in specified locations both to protect the cables and to minimize space requirements. Additional shear reinforcement was provided locally in the coffer ribs. (Fig. 19).

Hung floors

These are 200mm solid slabs. Support points for the hung slabs were confined to the intersection of ribs in the main slab, but the choice of intersections depended on the plant layout. Often they were irregularly placed, not at the optimum structural spacing. These slabs were designed using yield line technique. (Figs. 20 and 21).



Fig. 17
Typical main floor plan of the treatment plant

Fig. 18
Treatment plant : B line wall (south side of building) (Photo : Robal Studios (Pvt.) Ltd.)

Fig. 19
Coffer rib with additional shear reinforcement

Fig. 20
Treatment plant building : fourth and fourth intermediate hung floors showing 'C' line column and B-C box columns (Photo : Robal Studios (Pvt.) Ltd.)

Fig. 21
Treatment plant building : sixth floor and sixth intermediate floor showing openings for cyclones in intermediate floor (Photo : Robal Studios (Pvt.) Ltd.)



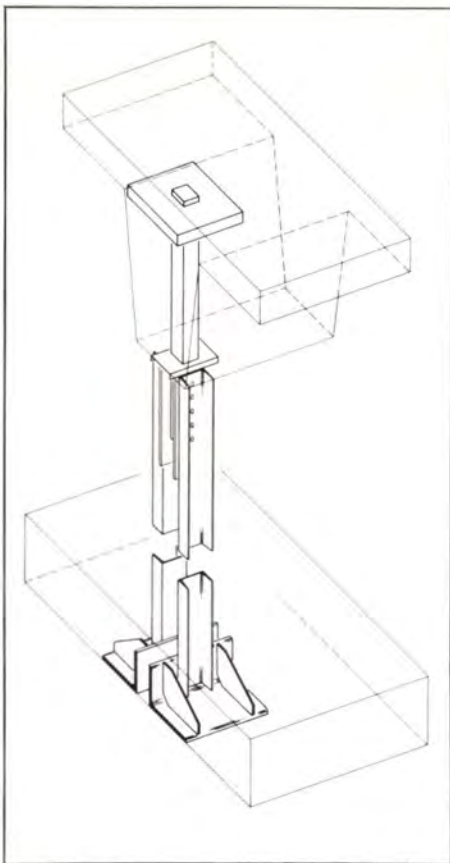

Fig. 22
Perspective view of hanger design

Hangers

The design of the hangers removed them as a restraint on the construction critical path as they did not interfere with the propping of a slab or of the subsequent slab. The hangers are encased in concrete for protection.

Fig. 22 shows the hanger design and Figs. 23 a, b and c show the sequence of constructing the main and hung floors.

Box columns

These have 250mm walls. Structurally their function is to provide vertical supports and lateral stability. The internal walls and floors were cast after the outside shell.

Columns

One standard size of $0.75 \times 1.5\text{m}$ was used for all columns. Their bending stiffness relative to the slab permitted a reduction in the overall design moment of the slabs.

Precast cladding units (Fig. 24)

The total area of cladding is $30,062\text{m}^2$. Precast concrete, structural steel supporting asbestos/cement sheets and glass reinforced cement panels were among the alternatives considered. The cladding needed to be sturdy and durable as replacement or repairs would be costly and difficult. The precast concrete solution turned out to be the cheapest and the one which best suited the client's requirements. The typical panels are $6.5 \times 1.5\text{m}$ in size with a mass of 1480kg (Fig. 25). Two windows per panel are provided to give a human scale to the units.

The vertical joints between panels are open-drained with a baffle strip and an air seal. The setback in the building between the ground and the first floor simplified the waterproofing detail at the ground floor and provided a covered walkway around the building. Brickwork was used between the ground and the underside of the first floor. A precast solution used up to the underside of the first floor on King Mill treatment plant project proved costly, because the numerous openings at this level resulted in a number of

8 non-typical panels.

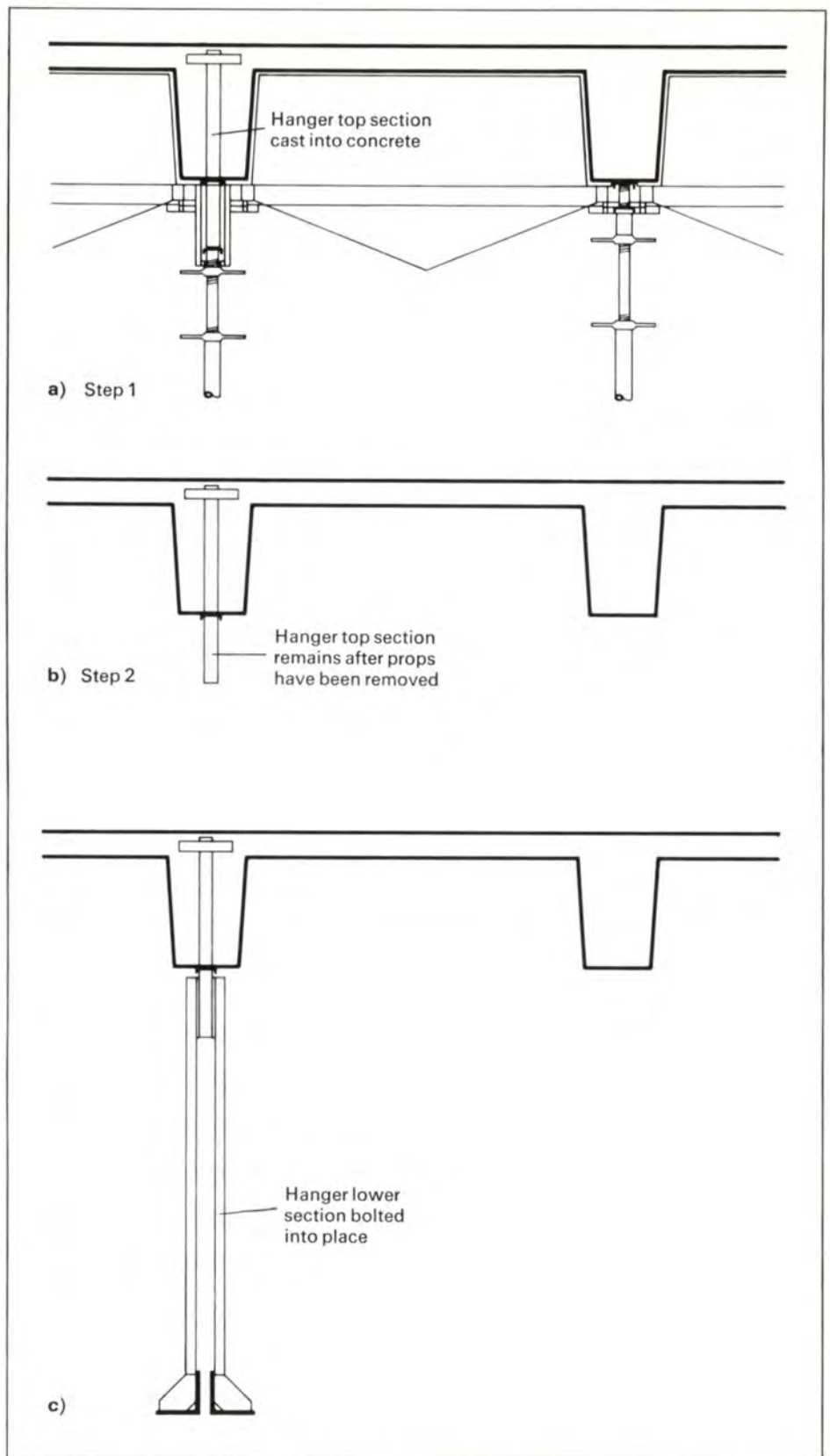
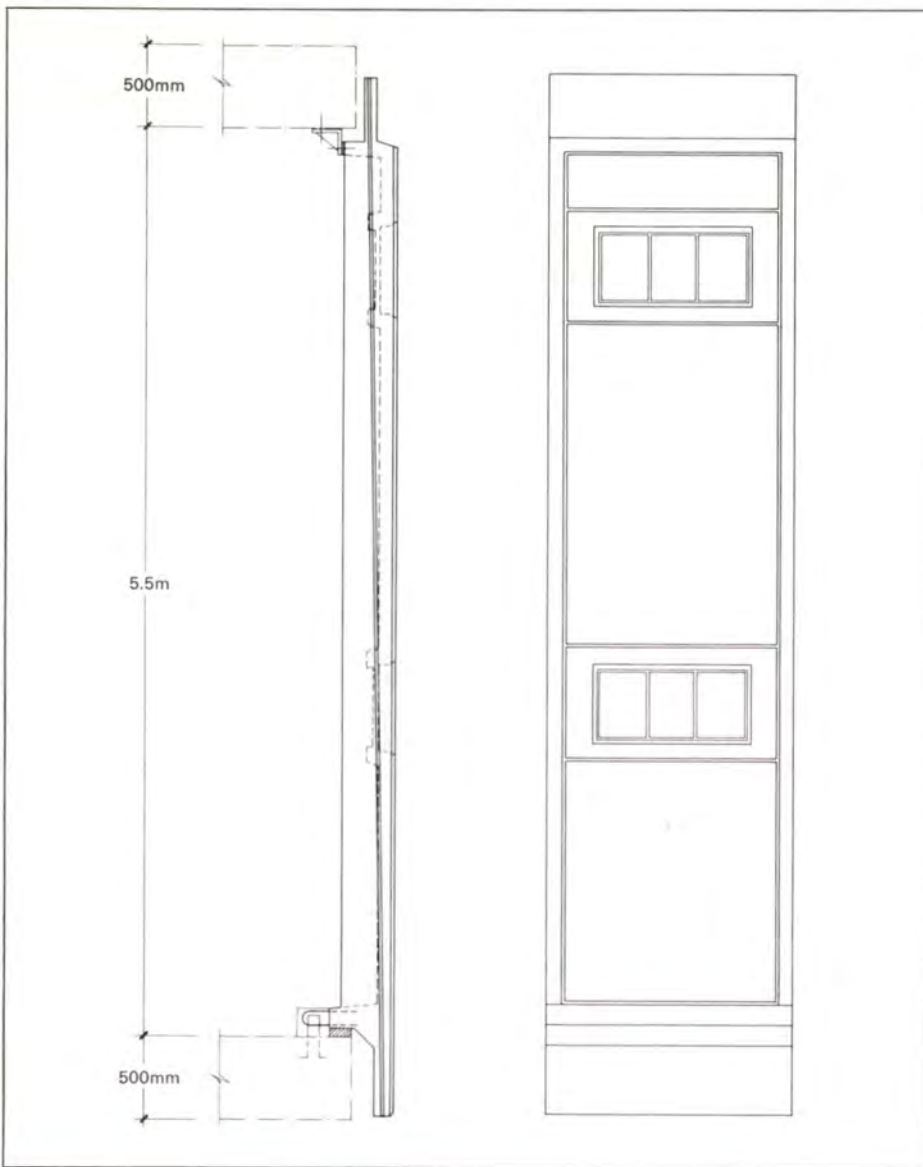

Fig. 23
Sequence of constructing the main and hung floors

Fig. 24
Precast cladding units
(Photo: Ove Arup & Partners Zimbabwe)





Construction

The use of standard elements made possible a fast rate of construction on the site. A minimum programme of 19 days per floor was achieved, with an average of 26 days per floor. The maximum concrete pours were in excess of 400m³ per day (Fig. 26).

Four tower cranes, each capable of lifting 2,500kg at full reach were used on the treatment plant. Concrete was supplied from two mixers on the east and west of the building. Their maximum delivery rate was 15m³/hour each. Concrete was moved into position either in skips or by pumping. The maximum output of the pump was rated at 50m³/hour, but this was never achieved as it exceeded the rate of the mixer. Pumped concrete was used for the entire height of the building. Concrete slumps were 35-45mm and 85-100mm for conventionally placed and pumped concrete respectively. In the solid columns only conventionally placed concrete was used. Elsewhere both types of concrete were used interchangeably.

The main slabs were formed with fibre glass moulds and steel pans supported on tubular steel props, at 1.5m centres each way (Fig. 27). The support system allowed for the removal of the coffer mould, leaving props in place at the intersection of the ribs. For typical areas reinforcing was made up into cages before being lifted onto the deck, and then joined together using splice bars. The amount of steel fixing done in place was kept to a practical minimum.

The 200mm hung slabs were formed using steel pans, carried on beams, supported by steel props spaced on a 1.5m × 3.0m grid.

Fig. 25

Typical precast panel

Fig. 26

General view of treatment plant building, packed fibre store and mechanical equipment store (Photo : Robal Studios (Pvt.) Ltd.)

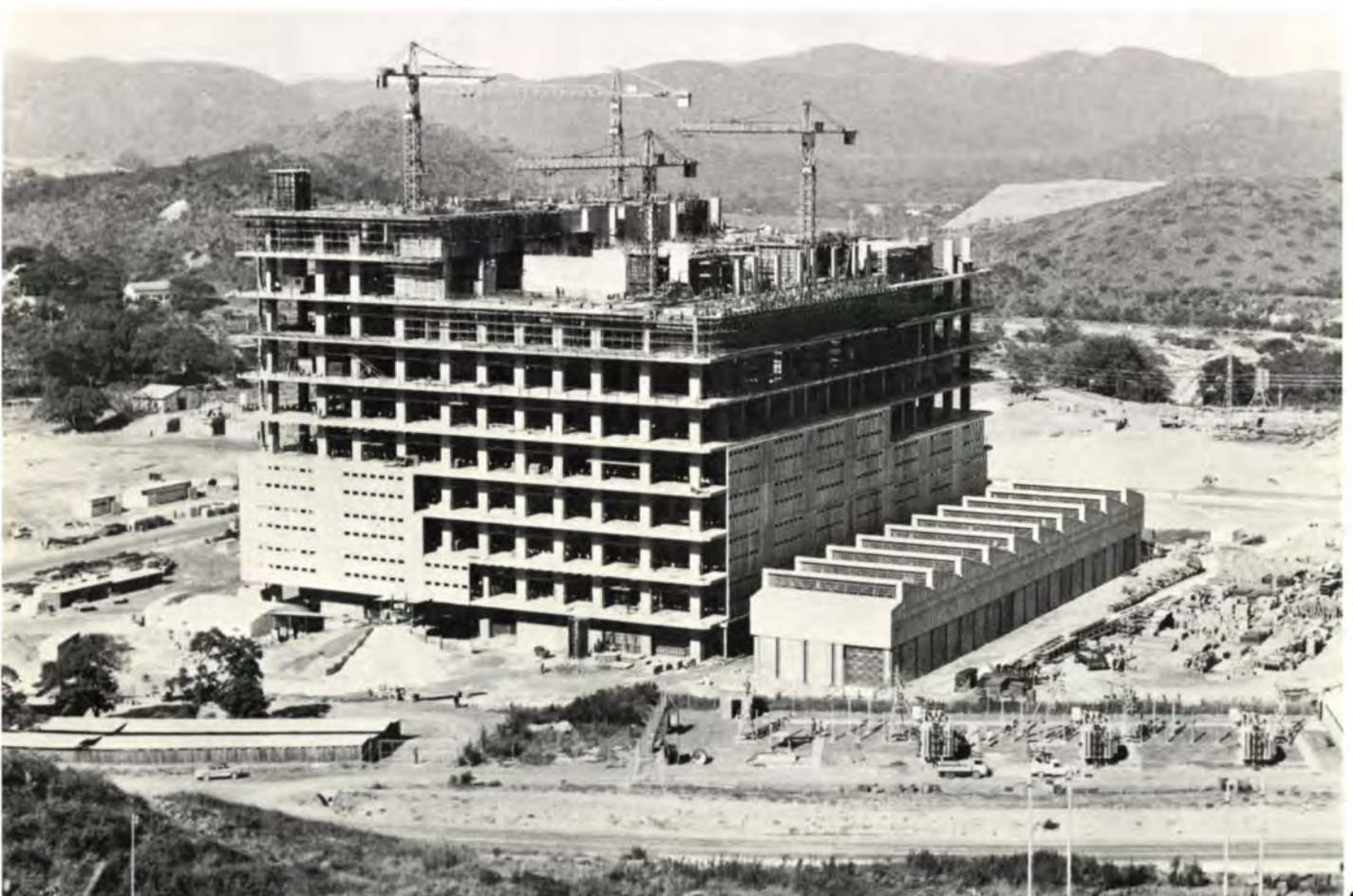

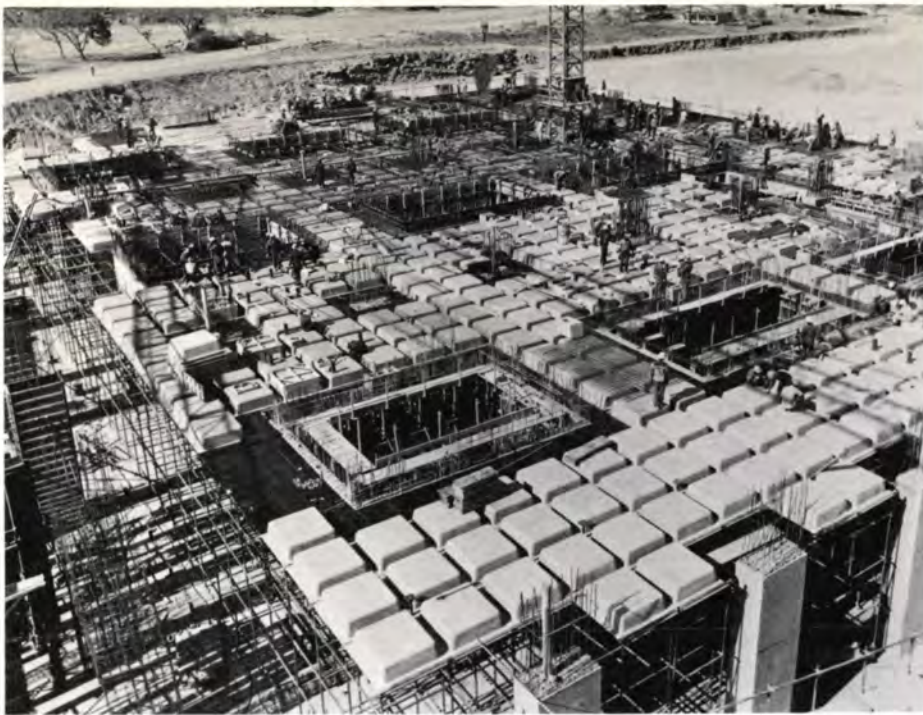

Fig. 27
Treatment plant : second floor coffers in position and steel being fixed
(Photo : Robal Studios (Pvt.) Ltd.)

Again it was impossible to remove the pans while leaving the props in place. Welded wire mesh was used for top and bottom reinforcing over the entire slab. Cut-outs for openings were made on site and additional reinforcing added at supports and around openings.

The hollow columns and all other walls were formed with gang forms. Where possible, prefabricated reinforcing panels were used.

The walls were poured continuously over the 5.5m height in approximately 2.0m lifts. The internal walls and slabs were cast afterwards.

Reviewing the design and construction of the treatment plant in retrospect, one structural element that could obviously have been better designed was the box columns, especially as they were on the critical path. Unfortunately the mechanical designers could not maintain

the slab module in the vertical direction and openings in the walls occurred almost anywhere. This complicated the design and the detailing, thus causing delays in the construction. Had this restraint been fully appreciated at the outset it may have been possible to provide structural columns in the corners with large non-structural infill panels which could have been added later.

Solid columns were cast using steel box shutters. The reinforcing cages were prefabricated.

The precast concrete cladding units were cast in a yard adjacent to the site. They were lifted onto the buildings at night using the tower cranes.

A qualified surveyor was attached to the resident engineer's team to monitor the

accuracy of the building. External reference beacons were used to establish internal control beacons at ground level. These four corner points were then transferred upwards with a precision optical plumb to provide a replica of control for construction work on each floor.

Specific construction lines were then established at each construction level by theodolite observations and offset measurements from this control grid. From these, reinforcing and shuttering were erected and checked before concrete was poured. Ideally these secondary construction lines should have been set out and adjusted proportionately between the main framework before construction work commenced. However, as it was not practical to complete one floor before proceeding to the next, setting out work had to be carried out piecemeal, usually from one corner of the building.

The points and lines established in this manner on upper floors were checked from time to time by direct observation and measurement to external beacons. By and large the monitoring of construction work was carried out using a combination of triangulation, precise traversing and levelling from outside control beacons or new stations established in convenient positions. A system was devised to continually check all 165 columns and points of structural significance and process the results by computer. A program was developed to calculate the grid co-ordinates of each corner of all the columns, top and bottom, on each floor from a series of adjusted traverses along each line of measurements, north/south and east/west, closed on the outside main grid control lines. This data was used to determine the positions of each column at each floor level in turn, relative to adjoining columns in a horizontal plane and to the same column at a level immediately above and below the particular level concerned.

A survey was carried out on the effects of changes of temperature on the structure, both during construction and to the completed building. The results of this survey were negative; if there was a temperature effect it could not have exceeded the known accuracy of the survey work of $\pm 4\text{mm}$ standard deviation.

Fig. 28
Histogram showing difference between surveyed and design positions of the centre of gravity of columns

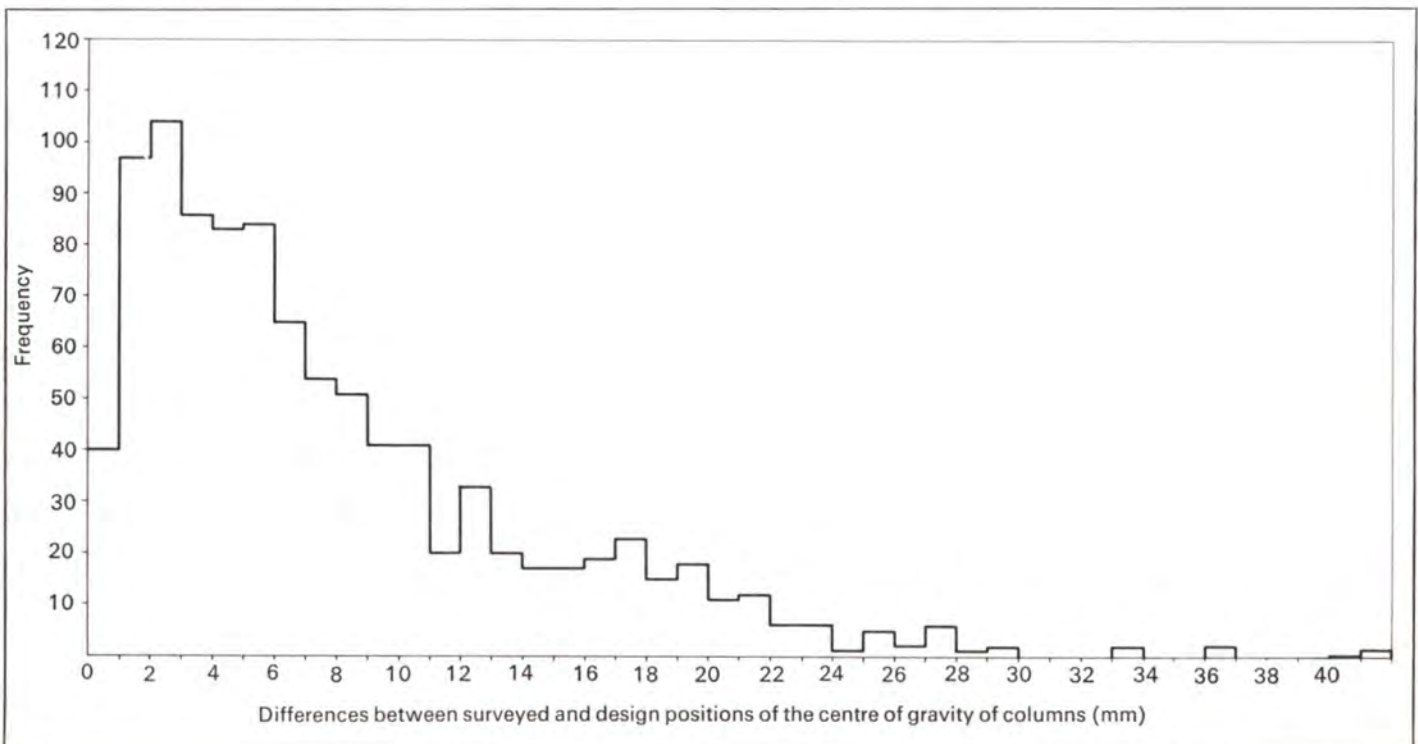

From the results obtained shown in Fig. 28 for the difference between surveyed and design positions of the centres of gravity of the columns, it can be seen that 1.6% of the results are greater than 25mm and 5% are greater than 20mm. The results for the difference between surveyed and design positions of column corners were similar with 1.7% of the results greater than 25mm and 4.7% greater than 20mm. The allowable tolerance was 25mm. The allowable tolerance for the difference between the position of column corners at the top and bottom of the same column was 20 mm. 5% of the results were outside tolerance, 2% were greater than 25mm. The allowable tolerance for the difference in position of column corners directly above and below a slab was 30mm. 1.5% of results were greater than 30mm and 4.0% of results were greater than 25mm. The above percentages were obtained using between 1,000 and 2,000 results and it is felt that this gives a reasonably accurate result for the entire building. It is interesting to note that the accuracy of positioning columns appeared to increase up the building with a considerable increase between the third and fifth floors, which coincided with the arrival on site of a full-time surveyor.

The actual position of the centre of gravity for the vertical structure was determined at each floor. The largest distance from its design position was 9.9mm at the top of the second floor.

The geometry of a building such as the Shabani Mill is important from two points of view. Firstly from the structural point, where eccentricities can cause significant secondary stresses and, secondly, for pieces of equipment such as conveyors, lifts, etc., it is important that the structure does not move out of plumb by more than the specified tolerance.

Civil engineering building contract

The civil engineering contract for all buildings in the mill was negotiated with Grinaker (Africa) (Private) Ltd. Briefly, the contract was handled as follows:

During the preliminary design phase of the treatment plant, a bill of quantities based on provisional quantities measured from sketches was prepared. Using these quantities and their make up, rates were agreed by Arups and Grinaker. As final drawings became available at each level, they were measured and the agreed rates were applied to these quantities. In a similar way, separate bills were prepared from sketch plans for all buildings in the feed systems, and then remeasured from final drawings. The treatment plant rates were used throughout, except where a new skill was involved in which case a new rate was agreed. The cost plan which was prepared before construction commenced was updated monthly as information firmed up. These costs were fed to the client who kept an overall cost plan for the project. Escalation was based on actual changes to the make up of the rates and was applied as it occurred.

Local material and labour

The availability of local materials and skills were significant factors in the choice of the structural concrete solutions for the different buildings which make up the mill. Concrete aggregate used on the project consisted of:

(1) Coarse aggregate

A medium grained granite of reasonably satisfactory quality obtained from Siboza Quarry approximately 10km from site. Inconsistent gradings and poor shape of this aggregate required close on-site attention.

(2) Fine aggregate

River sand won from the Shabi River approximately 10km from the site. The fineness modulus varied from 2.3 to 3.6 which again required strict on-site monitoring.

(3) Pit sand

Two sources of pit sand were used. These were 2km from the site on the Shabi River and 25km from site on the Nyaratedzi River.

An on-site concrete team was established to control the design and placing of the concrete. All aggregates complied with the requirements of the *Central African Standard CAS:A34:1969*.

Reinforcing bars available on the project consisted of:

(1) Square twisted high yield 30, 25, 20, 16, 12 and 10mm with a characteristic strength $f_y = 410\text{N/mm}^2$

(2) Hot rolled round mild steel 30, 25, 20, 16, 12, 10, 8, 5.5mm with a characteristic strength $f_y = 250\text{N/mm}^2$
Maximum bar length 12m.

(3) Pre-stressing wire. The only size available locally was 4mm diameter strand with a characteristic strength $f_y = 1700\text{N/mm}^2$.

Steel sections available locally consisted of the following maximum sizes:

- (1) 152×76×18kg/m channels
- (2) 230×25×45kg/m flats
- (3) 100×100×17.8kg/m angles
- (4) 65×140×14.3kg/m I beams.

Larger sizes were available but required the expenditure of foreign currency.

Labour was available in the area, but in most cases with no previous experience. During the site levelling and basement excavation phases of the project, a training school was established on the site. Gangs were trained on each specific standard building element by the civil contractors. Construction techniques devised by the civil contractor's senior site staff enabled a high standard of construction to be achieved with the minimum use of skilled labour. The majority of their management and supervisory staff had to be imported especially for this project.

Electrical design

The following statistics give the scope of the electrical installation which was completed for a cost of Z\$14 m., between the period January 1977 and June 1981.

Number of drives	4,000 plus
Installed transformer capacity	42 MVA
Reactive power	16 MVAV
Service voltages	11,000/3300/ 550/400/230
Light fittings	12,000
Total length cable	700 km (Figs. 29 and 30)
Equivalent single core cable	10,000 km
Number of control connections	500,000
Electrical staff (at peak)	26 Design office, 4 Site
Contractor's staff (at peak)	80

Control system selection

It was necessary for the efficient operation, the utilization of labour and effective management, that the large number of drives present in this plant were centrally controlled, supervised and monitored. The high cost implications resulting from down time of the plant make it essential that any control applied is as effective and simple as possible, whilst simultaneously offering the maximum in terms of fault diagnostic aids and fast component replacement type.

The following systems were considered for the fundamental control of the plant:

- (a) Computer based equipment.
 - (i) Programmable logic controllers (PLC)
 - (ii) Micro processing units (MPU)
- (b) Solid state logic (SSL)
- (c) Electro-mechanical relays logics (EMRL)

Investigations revealed that the local (Zimbabwe) suppliers had neither the expertise nor facilities to provide this type of equipment on the scale necessary for the requirements of this project. Enquiries were, therefore, directed at the more prominent external suppliers. The analysis of these enquiries was then used to firm up on a satisfactory solution to the control problem and to open negotiation with prospective suppliers.

(a) Computer-based equipment

(i) Programmable logic controllers

This class of equipment is cost-effective only where a high degree of logic in terms of input related to output is necessary. From preliminary enquiries it was evident that the cost of this type of equipment was in order of 200% more than that of the other alternatives. For this reason PLC devices were given little consideration.

(ii) Micro-processing units

This equipment proved to be slightly more expensive than the remaining alternatives but was not disregarded for this reason. Personnel with adequate technical expertise are at a premium in Zimbabwe. Recruitment of the requisite calibre of staff always presents a problem. Another consideration weighing the decision in favour of the simpler systems was the high obsolescence rate of computer equipment and its associated spares.



Fig. 29
Typical cable racking,
below main floor coffered slab

Fig. 30
Cable access to sub-basement (below MCCs)



(b) Solid state systems

Solid state switching can be considered statistically superior to the electro-mechanical relay with its attendant moving parts. However, the disadvantage with this system is the low susceptibility to line-borne noise. Unfortunately, disturbances of this nature cannot be analyzed at the design stage.

Light current technicians necessary for the maintenance of solid state systems have generally progressed to higher employment status and are not particularly interested in maintenance positions. The residue of staff available for maintenance is usually an electrician who eludes or offers resistance to black box techniques.

(c) Electro-mechanical relay logic

This equipment without doubt offers the greatest degree of operational stability. It is to a large extent insensitive to disturbances that generally create havoc on the more sophisticated systems. No special knowledge is required for application. Further advantages are realised from the basic simplicity of this system. Maintenance staff usually possess a rudimentary understanding of these systems and are therefore reasonably confident of their ability to analyze, and subsequently rectify, in an expedient manner, 99% of most faults that occur.

With an assessed maximum of six operations per hour per relay and a quotient of 106 number of operations, the probable reliability term of this class of equipment would be in excess of 20 years.

Conclusion

On the basis of the foregoing considerations, the circumstances particular to the project, reference and liaison with other end users, it was our opinion that the electro-mechanical relay logic would best fulfill the requirements of this project.

It was decided that, in addition to the mimic display, a data logging system should be provided to record faults and the time at which these faults occurred. It was therefore necessary to perform this function with a computer-based microprocessor unit (MPU). It may be argued therefore that the use of the MPU for data logging purposes lent viability to the economical use of a computer-based control system. However, feasibility studies indicated that the cost savings were insignificant. Furthermore, the mode of operation

of the data logger is such that no influence on control is exercised. Malfunction of this system does not therefore result in plant stoppages.

Description of control system (Figs. 31 and 32)

To meet the criteria of the provision of fault diagnosis aids along with a quick component replacement time, special cards were designed. Each motor control circuit was then allocated a standard drive card. These cards were manufactured from printed circuit bases before being loaded with the necessary relays and light emitting diodes (LED) to provide both control and fault diagnostic functions (Fig. 33).

Supplementary cards (auxiliary) were employed to provide such functions as timing interludes and contact amplification.

The relays and components fitted to the above mentioned cards were selected for 48 volt DC, this being the highest available operating voltage for miniature framed relays.

The drive control and auxiliary cards were accommodated in card files which were then rack-mounted.

Integral to these relay racks are marshalling and interlocking matrices which allow connection of field inputs to the drive cards and the subsequent sequencing/interlocking pro-

grammes are carried out at the interlock matrix. (Figs. 34 and 35).

Both the inputs and outputs of the drive and auxiliary cards are represented at the interlock matrix in the form of sockets. Flying leads with corresponding plugs are then employed to patch up the desired sequences. A mimic display was provided to indicate the process flow and drive status, the status being confirmed by a multi-state indicating lamp. The lamp indicates the following conditions:

- Red-field isolator open/stop button operated
- Amber (flashing) – alarm condition
- Green – drive running
- Blue – item excluded from operation.

The mimic lights are driven from the respective drive cards, the signals being conveyed via 50 core cables. The digital signals driving the mimic display were also employed as status inputs to the event-recording data logger. Again 50 core cables were utilized to transmit this information from the mimic to the data logger (Fig. 36).

Control cabling

The extremely high density of incoming and outgoing information to and from the relay racks, mimics and field control stations made it necessary to develop a special scheme.

Fig. 31
Typical hook-up diagram

Fig. 32
Illustration of typical drive interlock

Fig. 33
Typical drive card

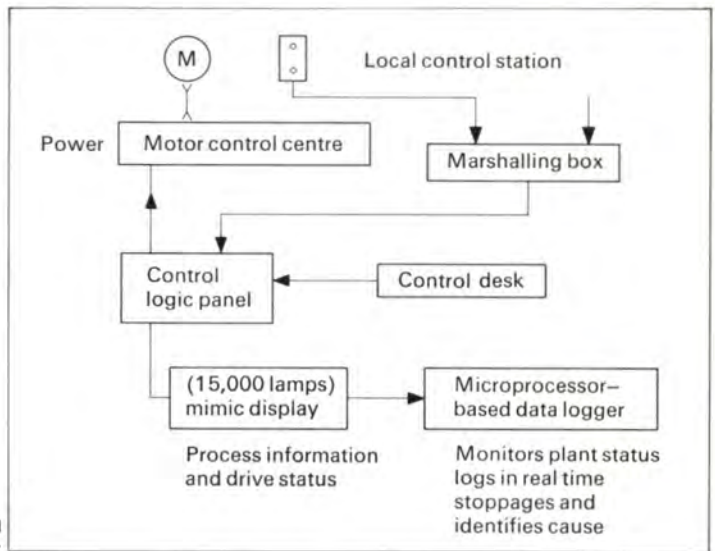

31

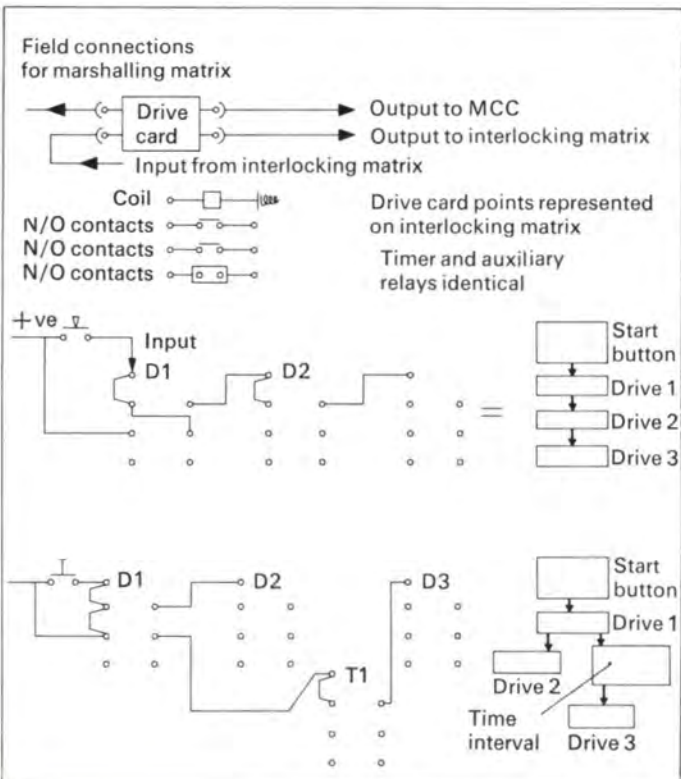

32
33

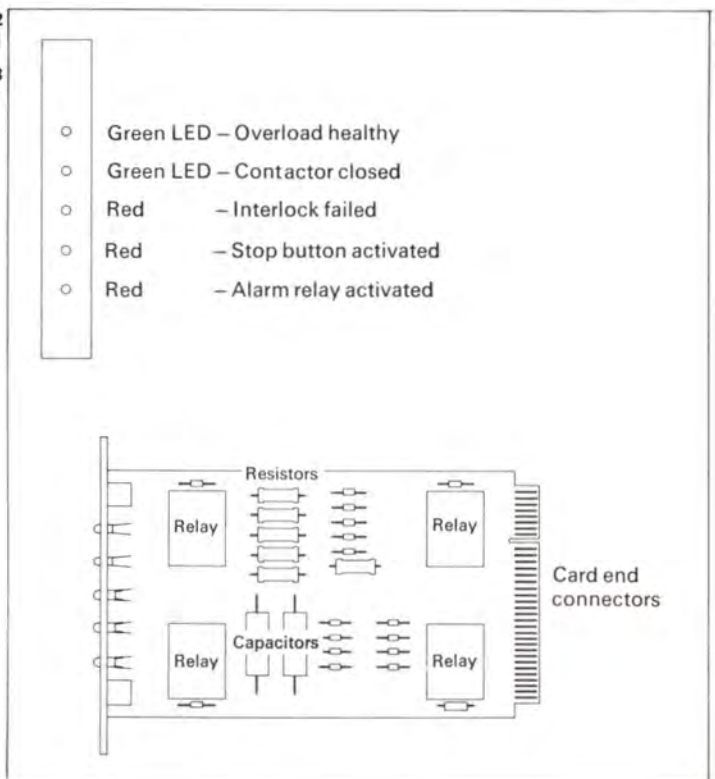



34▲

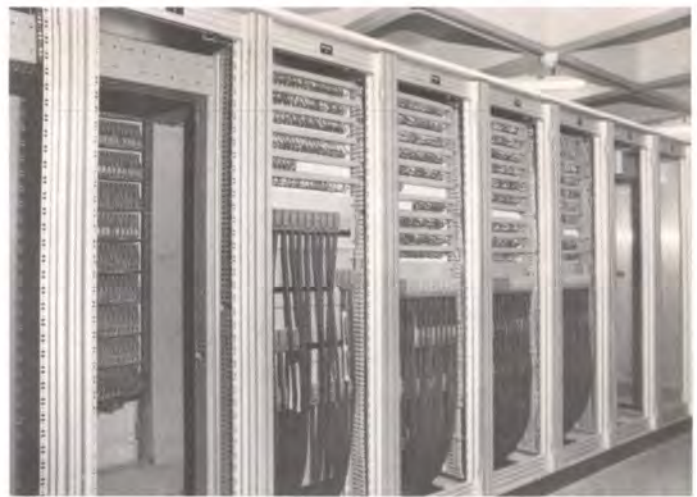

35▲

36▼

Fig. 34

Front view of relay rack showing interlock matrix (note roof-mounted smoke detectors)

Fig. 35

Rear view of relay rack showing marshalling matrix

Fig. 36

Control room showing mimic panel and control desk

Fig. 37

Motor control centres (1 line)

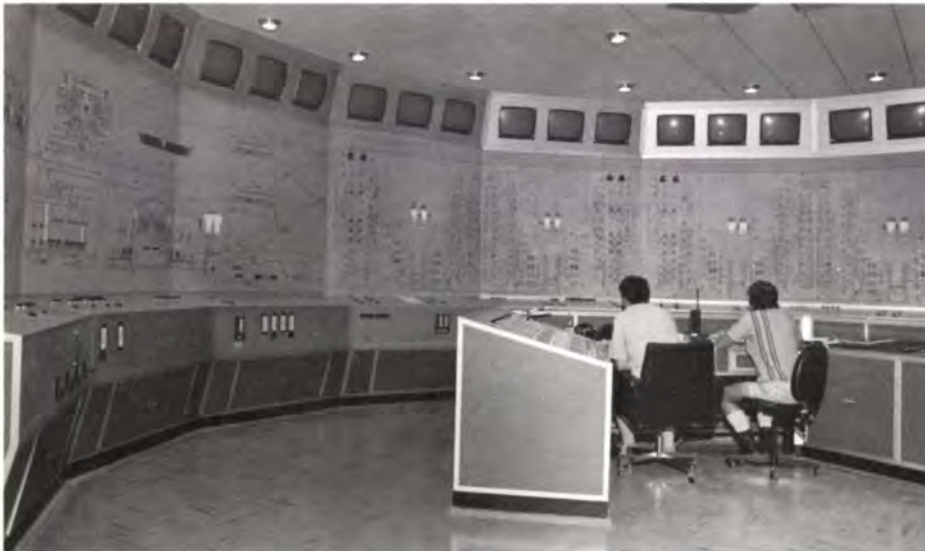

When it is considered that the average drive has 11 incoming/outgoing connections with approximately 3,600 drives, the number of terminating points at the relay racks are therefore in the order of 40,000. To terminate this amount by conventional terminals, each 3mm thick, would have meant that the total termination area would have been prohibitive. For this reason high density aircraft type plugs and sockets were employed for these

connections. Each plug/socket arrangement accommodates 50 connections in an area approximately 25×60 mm. The total area required was therefore approximately 1.2m^2 . A further advantage gained from the use of these connection arrangements was the greatly reduced termination time, i.e. if 10 minutes are allowed per connection for conventional screw type terminals, 40,000 terminals would require 6,666 hours.

The 50 core plugs each required approximately 15 minutes to terminate results in a revised time of 200 hours. This was obviously a significant saving, particularly in view of the fact that the 40,000 terminations were very nearly duplicated at the mimic and data logger.

The use of 50 core cables, where possible, obviously offered major savings in terms of service space required and cable installation time.

Conventional armoured cables were employed in the open areas of plant where the probability of damage exists.

Motor control centre (Fig. 37)

Motor control centres were designed and manufactured in such a manner as to facilitate expedient component change. To this end the smaller motors (up to 37kW) being in the majority, and subject to a greater number of operations, were equipped with completely withdrawable starters. With this facility it is possible to change the complete starter module in less than two minutes.

Interfacing the motor control centres to the relay racks was achieved by the use of encapsulated pluggable 48 volt DC relays which switch the 110 volt AC via interposing relays, 110 volt AC being the operating coil voltage of the 550 volt AC motor starter circuits.

Advantage was taken of the large quantities of starters involved to mass-produce from jigs all metalwork, bus-bars and associated support components.

Transformers

A load analysis on the basis of 0.55 amp per kW indicated that it was necessary that the lines each required 1.6MVA transformers. However, this allowed a negligible amount for future growth. On this basis it was therefore decided that 2MVA units should be installed. 13



Fig. 38
Treatment plant
transformer yard



Fig. 39
Typical arrangement
of connections
to 2 MVA transformers
(HV & LV)

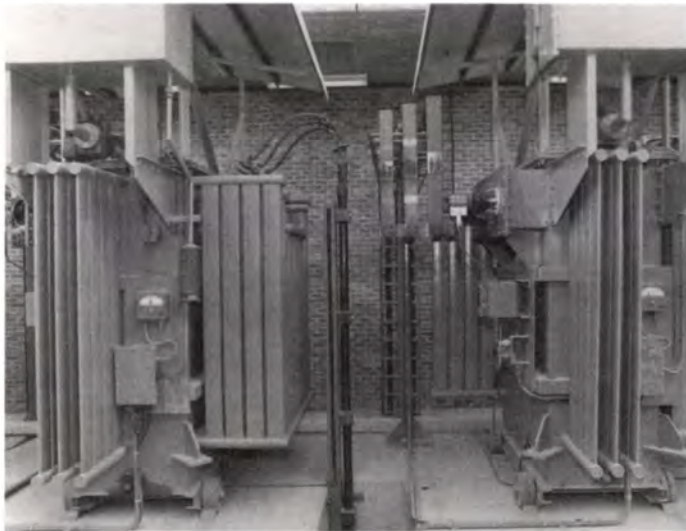

Fig. 40
31 panel 11kV
main switchboard



In the interests of interchangeability and the effective utilization of spares, these units were used throughout with the exception of the larger (3MVA) 11,000/3,300 volt units needed to operate the main fans and miscellaneous other units for lighting and services (Figs. 38 and 39).

Lighting small power

The lighting system allowed for a basic level of 300 lux, supplemented in areas considered necessary. All fluorescent lights were fitted with quick release gear trays and 5 amp plug tops to achieve connection. This allows removal/replacement by unskilled labour.

Reactive power installation

The Zimbabwe scale of tariffs for the supply of electricity is based upon an annual charge for the maximum demand value reached at any instant during the financial year.

With anticipated values in excess of 42MVA, uncorrected and calculated maximum of ± 36 MW, the capital costs of the reactive power installation (16MVA) will be offset in the first two years of operation.

The 4×4 MVA banks are automatically switched by reactive power relays. This is necessary, particularly as the plant may be run in sections, which would lead to over correction and subsequent over voltage, in the event of too much reactive power being inserted (Fig. 40).

Conclusion

The success of any project depends mainly on teamwork. AAM leadership and design skill formed the backbone of the entire project team and the completed Shabani Mill is a great credit to their organization.

This project is one of the biggest structures in Zimbabwe and it shows that even large projects like this can be successfully completed with the minimum expenditure of foreign currency providing the right use is made of local resources. There is no doubt that, like the King Mill before it, it will benefit not only the people in the area but also the entire country. For all those involved in the design the experience was challenging, interesting and above all tremendous fun.

Credits

Client:

Shabani and Mashaba Mines (Private) Ltd. are the owners and operators of Shabani Mine. African Associated Mines (Private) Ltd, are Secretaries and Consultants to Shabani and Mashaba Mines (Private) Ltd.

Project management:

M. G. Webber,
Technical director

Design leader:

H. J. C. Shone,
Mechanical engineering consultant

Electrical design:

J. M. Pattison,
Electrical engineering consultant

Mechanical and electrical installations:

M. Lewis,
Chief construction engineer

Commissioning:

J. Scholz,
Chief construction engineer

Consulting civil, electrical and structural engineers:

Ove Arup & Partners

Project partners:

R. A. Heydenrych
E. S. Walker

Project structural engineer:

M. B. Noyce *

Project electrical engineer:

H. P. Gill *

Project civil engineer:

J. P. Casson *

Project co-ordinator:

A. R. Allester

Senior resident engineer:

T. E. H. Fawcett *

*Authors of this Journal assisted by J. E. Goddard and R. M. Lamb.

Consultants to Ove Arup & Partners

Quantity surveyors:

J. M. Coom (Partner),
J. Thrasher (Partner),
Walter Simpson, Coom and Morant

Architect:

M. N. Clinton (Partner),
Clinton & Evans

Main contractors for civil and structural works:

Grinaker Construction Africa (Pty.) Ltd.

General manager, construction:

T. N. van der Walt

Construction co-ordinator:

L. A. Gluckman

Project site manager:

H. de Bruyne

Site manager, construction:

J. Armstrong

Site agent, construction:

R. Allen

Electrical contractor for treatment plant power installation:

Electroreps (Pvt.) Ltd.

Director:

M. Guard

Site agent:

E. Gustafson

Electrical contractors for treatment plant lighting and small power, plus complete installation for feed system:

H.W.S. Contractors (Pvt.) Ltd.

Manager:

J. Barker

Site agent:

P. Binns

Photos: Bob Davey,
(except where otherwise credited.)



