

# THE ARUP JOURNAL

RONALD JENKINS MEMORIAL ISSUE

APRIL 1976



# THE ARUP JOURNAL

Vol. 11 No. 1 April 1976  
Published by  
Ove Arup Partnership  
13 Fitzroy Street, London, W1P 6BQ

Editor: Peter Hoggett  
Technical Editor: John Blanchard  
Art Editor: Desmond Wyeth FSIA  
Editorial Assistant: David Brown

Ronald Jenkins Memorial Issue

## Contents

|   |    |
|---|----|
| Introduction by John Blanchard  | 2  |
| Tributes,<br>by John Henderson<br>and Peter Smithson                                      | 2  |
| Thin section edge beams   | 4  |
| Prestressed thin section edge beams   | 10 |
| Matrix analysis applied to<br>statically indeterminate structures                         | 12 |
| Towards a variational method<br>for the static equilibrium of<br>curved bodies and shells | 30 |
| Membrane theory in<br>general co-ordinates by<br>matrix-tensor methods                    | 34 |

Front and back covers: Teak dome, Assembly Hall, Rangoon University, Burma:  
Superimpositions of stress trajectories on plan and principal stresses on plan

## Introduction

John Blanchard

This issue of the *Arup Journal* is designed as a tribute to Ronald Stewart Jenkins who died on 27 December last year.

This tribute takes the form of a presentation of his work with particular emphasis on his theoretical achievements. This seems wholly appropriate because of his significant contributions to the development of the firm and to the advancement of the practice of structural engineering and analysis in this country. Through his work, too, are revealed some of his outstanding personal qualities; the power and clarity of his mind, his stamina and dedication, his love of order and meticulous attention to detail.

After graduating at Imperial College and one year's post-graduate study, Ronald Jenkins became Assistant Engineer in 1931 to Oscar Faber and Partners. From 1935 to 1938 he was a Senior Engineer with J. L. Kier and Company. He was Chief Engineer for Arup & Arup Ltd. from 1938 to 1945 where his most notable work was the design of a fendering system for the Mulberry Harbour.

When Ove Arup set up his own firm of consulting engineers in 1946, Ronald Jenkins joined him there, becoming a Senior Partner in 1949 until his retirement in 1973 when he became a consultant to the firm. Whilst with the firm he was responsible for a large number of important structures, many with shell roofs. Projects worth particular mention were the factory for the Brynmawr Rubber Co. Ltd., the footbridge at the Festival of Britain (one of the earlier applications of prestressed concrete in this country), Hunstanton Secondary Modern School, Kidbrooke Comprehensive School, the Bank of England Printing Works at Debden, a timber hyperbolic paraboloid roof at Market Drayton, aircraft hangars at Gaydon and at Abingdon, the Concourse at the Sydney Opera House and the initial structural design for the roof there. His considerable output of publications is described later in introducing some of his unpublished papers to which this issue is largely devoted.

## Tributes

by John Henderson

The early years of the beginning of 'Arups' may seem like yesterday to some, but to others it is ancient history. At that time, this country was then only too well aware of its insular geography and of the protection this might hopefully afford against the attentions of the invader. In some other ways, however, our long insularity was not so helpful, not least in the field of structural mechanics. Not only was teaching almost totally detached from the best continental work, but also many of the implications of the work of our own brilliant pioneer Clark Maxwell were left on one side as dusty relics and without much up-to-date significance.

It was under these auspices that RSJ set out in 1931, having completed his university training and started the career of the great engineer he was to become. For those who knew him in later years, his theoretical side may have appeared to be totally dominating. This view is quite misleading, since it was characteristic of him to apply himself with vigour to all aspects of construction, both practical and theoretical. As a small example, his design for the concrete pump hopper loading gantry at Eastbury Park (1942) was a model of engineering economy and grace. It was formed from a frame of telegraph poles supporting some old steel beams from the yard, these in turn carrying the roadway leading to the hopper. The erection was done speedily by a few men under an able ganger with no mechanical plant. Everyone knew it would be right for the job and be trouble-free (barring some event totally outside the terms of reference), since it bore the RSJ thumb print. Similarly, any contract estimate he made had the same distinctive character, and a site agent was fortunate indeed to have such a document as his price guide.

If I may return to RSJ's theoretical side, two events greatly interested him in the 1930's. The first, rather a minor one as it turned out, was the arrival of Hardy Cross's moment distribution, providing, as it did, a ray of hope for the designer: secondly, and of considerable signifi-

cance, was what might be termed the Danish invasion, bringing with it the then current European theoretical teaching of structural analysis.

The main interest centred on the analysis of statically indeterminate structures by flexibility coefficient methods and on various manoeuvres for improving the solution processes of the resulting equations. As Ove has mentioned, RSJ wasted no time in absorbing these ideas and in applying them in design, and then in battling with them himself. However, one vital key to the main puzzle was apparently still missing. This may conveniently be termed, in this short note, the 'Contragredient Principle' of force and displacement, nowadays better known as Static Kinematic Duality. I use the word 'apparently' circumspectly, since Maxwell himself had pointed the way in his astounding 1864 paper<sup>1</sup>. Other claims have been made for originators in this field, though further research appears necessary to establish the facts of the case. All this work was undoubtedly forgotten and had to be re-discovered. RSJ was the one who did it, using it thereafter as part of his designer's theoretical kit.

### The Contragredient Principle

The circumstances of its rediscovery, as far as I can recollect, came about in the following way. In 1941, RSJ had involved himself in a rather complex analysis of triangular continuous slab design for petrol tanks, resulting in a set of linear equations. By good luck, more than anything, I was able to suggest that this kind of calculation could be made more manageable with matrices. At that time, few engineers other than some perhaps engaged in the aircraft industry and working on mechanical vibrations, would have known a matrix if they had seen one. Relevant texts were obtained from Foyles, and RSJ saw their usefulness rapidly and, equally rapidly, absorbed most of the material of the four text-books, these being by Aitken<sup>2</sup>, Ferrar<sup>3</sup>, Turnbull<sup>4</sup>, and Turnbull and Aitken<sup>5</sup>.

These were the only books Foyles could produce at that time, and in many ways it was fortunate that the choice was so limited. The limitation had two advantages: firstly, the books were free of any engineering applications and, consequently, of any traditional theoretical structural bias, and secondly, Aitken was one of the principal authors. Professor Aitken's pithy, succinct style suited RSJ. Aitken's own special abilities show clearly in the text, for, while being brilliant as a mathematician, he was also a phenomenal calculator and possessed an extraordinary memory. These qualities were mirrored in RSJ's own abilities, since, together with possessing a keen mathematical intelligence, he was also a remarkable calculator of great physical stamina, relying on an incredible memory, especially for that of pattern.

After transforming his slab calculations into matrix form, RSJ could see that the force and displacement transformations were of a very similar form, and sufficiently like the contragredience of the text-books. For this reason, he termed the mating sets as being contragredient. The maintenance of a work invariant sufficed for a kind of proof – not that this probably concerned him much at that time. The evidence of pattern was sufficient for his needs, and probably an inborn instinct prevented him from using some theory incorrectly. Added to all this, of course, the axiomatic use of the contragredience principle produced the well-known equations as given by Ostenfeldt and other continental teachers.

After an interval of more than 30 years, it is extremely hard to be categorical about the minutiae, but broadly I believe that this is a reasonably accurate account of one of RSJ's achievements in theoretical structural analysis. Had he been a less organized and observant analyst he would probably have missed the idea, an oft-repeated statement about many a discovery, but nonetheless true. RSJ confined all his work of this sort to elastic structures, and all available evidence suggests that it is probable that RSJ did not know that contragredience applied equally to the inelastic case. Whether Maxwell considered the inelastic case or not is unknown, and almost certainly will remain so.

### Later years

In the next few years, he completed his setting out of flexibility coefficient methods in matrix form, and in 1947, although deeply involved in shell theory and design, he showed me this work written out on half a page of quarto typing copy paper. Here, contragredience was treated as being axiomatic. The succinctness of the note took a bit of getting used to, but that it demonstrated an important way of doing things there could be no doubt whatever. It was not published in any form at the time, which was regrettable, but it was fortunately made available in May 1954 as Paper No. 1 of the Euler Society<sup>6</sup>, whose primary function was quick publication of new work.

Returning to contragredience again, it should be said that the term as used by the authors of the four books mentioned previously confined their transformations to invertible matrices. Since RSJ's use of 'contragredience' applied to transformations which are rectangular, this includes the case of the previous writers if the inverse restriction is added. The generalized definition seems universal today. Some schools of thought objected to all this so-called mathematical jargon, preferring their own descriptive words, which were nevertheless still jargon.

Such then is the story of just one of RSJ's contributions to structural analysis, and it is characteristic of his approach to mathematics in

design. Basically, this was to use ideas if they worked or had a very high probability of doing so. How the story continues with his work in shell theory and design, for which he is probably best known, must be described elsewhere and at far greater length.

To end in a lighter vein, I have a vivid memory of a Brynmawr dome discussion on the boundary values appropriate for the stress function  $\phi$ . The discussion took place in a fog while going up the Old Man in Westmorland, and  $\phi=0$  was decided on at the top, while we were still in the fog. No great problem now, you might say, but things looked different then and not so obvious. I mention this last of all, since concentrated thinking and the peaks of Westmorland were two of his great joys.

### References

- (1) MAXWELL, J. C. On the calculation of the equilibrium and stiffness of frames. *The London, Edinburgh and Dublin Philosophical Magazine and Journal of Science*, 27, p. 294, 1864.
- (2) AITKEN, A.C. Determinants and matrices. Oliver and Boyd, 1939.
- (3) FERRAR, W. L. Algebra. Oxford University Press, 1941.
- (4) TURNBULL, H. W. The theory of determinants, matrices and invariants. Blackie, 1929.
- (5) TURNBULL, H. W. and AITKEN, A. C. An introduction to the theory of canonical matrices. Blackie, 1932.
- (6) JENKINS, R. S. Linear analysis of statically indeterminate structures. Euler Society, 1954.

## by Peter Smithson

In my work life I have experienced two kinds of very strong sensations: the first in the field of action where one suddenly has this marvellous feeling of 'being on the brink', when some series of apparently unconnected events can be suddenly seen as capable of providing a new beginning: the second sensation comes through reading or travel when one suddenly says 'That's where it all began'.

The early '50s was for me the time of one of those 'on the brink' feelings, and working with Ronald Jenkins was part of it. Let me remind you of what was happening in our special small world. Above all for us architects in post-war Europe, Le Corbusier's Unité D'Habitation was under construction in Marseilles. After a generation of talk about the form of the collective, at last someone was trying again, in a different Europe, to make a bold strike at its shape. The impact of the works in progress was a revelation, for Le Corbusier had invented an architectural language for reinforced concrete, a language that had been growing in his mind over the same apparently fallow years that were needed for Mies Van Der Röhé to invent a language for bricks and steel.

It was something to do with respect for materials, that the way of handling even the simplest of things had to be elegant in the mind as well as in the fact, and it was at this time, and at this level, we discovered Ronald Jenkins.

### Hunstanton and after

Now for the Hunstanton School competition I had calculated, in innocence, the sizes of the steelwork from a Ministry of Education bulletin on 'Light steelwork for school buildings,' or some such thing, and with the aid of good old Dorman-Long's crimson-backed section-book.

But for Ronald even such a modest task as the structure of a two-storey school could be elegant in the mind as well as in the fact.

Alison and I, Bob Hobbs and Jack Zunz worked those years with the pleasurable sense of being 'on the brink'. We felt that we were at the beginning of a more precise way of handling the properties of materials, and that both the language of engineering and the language of architecture would be greatly purified.

Ronald in his sleepy way was an incredible support, for he had also the presence and the practicality of the real professional. Alison and I met Ronald often at this time, especially during the long design period for the Coventry Cathedral competition. It took many months just to find a way of bringing the loads from the shell to the ground in a way that seemed to satisfy both the structural and the building-space motions. The essence of our relationship was of uncomprehending trust, for neither architect nor engineer could really enter the other's world.

In his later working years, when we saw him less frequently, we felt cut off from a comprehension of his work as the cogs of his talent seemed to engage less frequently with the real life of construction where those elegancies of the Jenkins approach would have been revealed to the outsider.

Ronald Jenkins was for us a co-worker in an exciting period, a patron, and a companion.

We are all diminished by his death

Ronald Jenkin's first major published work was his book *Theory of cylindrical shell structures* (1947). This presented the theory and computational methods that he had developed to analyse the cylindrical shell roofs of Donnybrook Bus Garage. Although shell roofs of this type had then been constructed, particularly in Germany, and numerous shell theories had been published, there was virtually nothing in the literature which described how the analysis could be carried out practically. An exception was Christiani & Neilsen's Bulletin No. 43 'Analytical calculation of anisotropic circular cylindrical shells', Copenhagen 1945, which had a great influence on his ideas.

Starting with Love's shell equations he obtained, after a thorough study of which terms were secondary and could be consistently neglected, a manageable partial differential equation of the eighth order. Derived independently by Donnell and Karman, this is known as the DKJ equation and is usually regarded as the canonical equation for cylindrical shells. He found a Fourier series solution for this which was valid for all cylindrical shells simply supported at their ends and incorporated the novel and powerful idea of splitting the solution into two parts in the form of damped waves originating at each edge of the shell. But for Ronald Jenkins finding the general solution was only the start; he did not consider a problem solved until he had devised an ordered process of appropriate rigour for obtaining numerical answers.

He realized that matrix algebra was the ideal discipline for this purpose and this led to one of the very earliest applications of matrices to static structural analysis. The compactness of visualization and presentation that this gave enabled him to deal properly with complex multi-bay shells with quite general arrangements of edge beams at the junctions of the shell. His formulation allowed the analysis of such a structure to be viewed as the analogue of a moment-distribution analysis of a continuous beam. Instead of a bending moment or rotation at the end of a beam, however, he was handling a  $4 \times 1$  matrix (vector) representing the stress resultants at the edge of each shell (ring tension, radial shear, ring moment and longitudinal shear) or the

corresponding deformations. In place of the simple stiffness and carry-over factors for each beam there were  $4 \times 4$  stiffness and transfer matrices. This ordered approach also allowed the calculations to be checked at each stage, a consideration to which he always attached great importance.

It will be appreciated that this process was organized to suit the mechanical or electrical desk calculators which were the most sophisticated aids to computation then available. Using these, even an experienced operator might take 30 minutes to invert a  $4 \times 4$  matrix. However, it has recently been found that the methods of this book can still be appropriate when a computer of moderate power is used, provided that a matrix-handling language is available. The reason for this is that the Fourier solution enables the state of stress throughout the shell to be defined with sufficient accuracy by eight numbers whereas hundreds of numbers barely suffice in a finite element treatment. Of course, the exact solution methods described in the book are now more appropriate than the distribution method (just as the moment-distribution method for continuous beams is now replaced by the slope-deflection equations when using a computer).

His orderly treatment of the shells imposed a similar and no doubt congenial discipline for the edge beams, simple members though they might be. It also required finding the appropriate transformation so that the actions and movements of all shells and beams at a junction might be referred to a common axis system. Ronald Jenkins had extended the treatment of edge beams in his book to cover thin-walled beams of open section (with and without prestressing) with the idea of including the addition in any new edition of the book. This unpublished work is printed here, partly with the idea of possible practical application. Sufficient justification comes, however, from the insight that it gives into the behaviour of this type of beam and its demonstration of his clarity of mind and precise attention to detail. It would seem fitting, too, to recall in this way the original pioneering publication.

John Blanchard

## Thin section edge beams

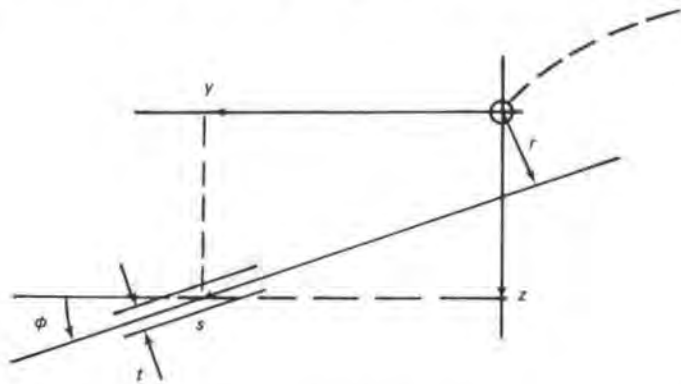

O is point where shell is attached to edge beam

y, z are co-ordinates of a point on the middle surface of thin edge beam

s is distance of this point from O measured along profile

phi is slope of middle surface at (y, z)

r is distance of tangent of middle surface from O, and is positive when direction  $\underline{s}$  is clockwise in relation to O

t is thickness

A three-sided edge beam is taken as an example:

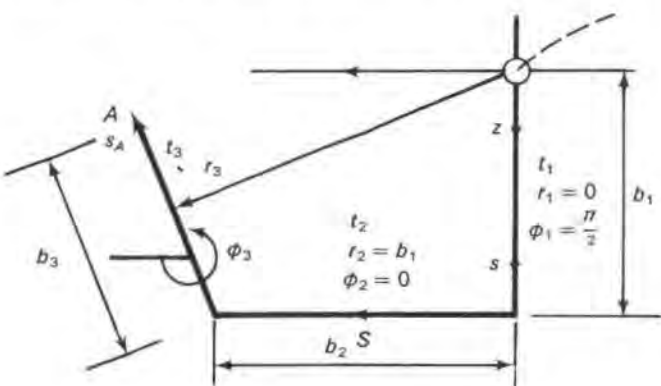

The tangential stress resultants we are concerned with are shown on developed plan:

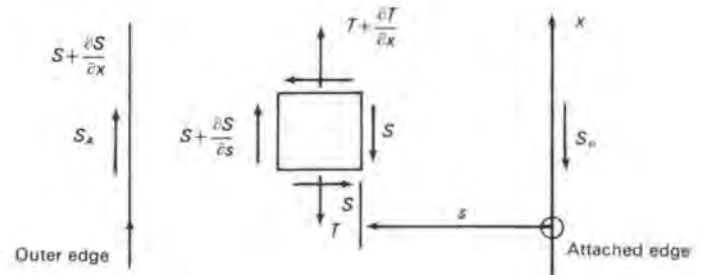

$$\text{Equation of equilibrium: } \frac{\partial T}{\partial x} + \frac{\partial S}{\partial s} = 0 \quad (1)$$

$$\therefore S = S_o - \int_o^s \frac{\partial T}{\partial x} ds = \int_s^A \frac{\partial T}{\partial x} ds \text{ when } S_A = 0$$

$$\text{i.e. } \frac{\partial S}{\partial x} = \frac{\partial S_o}{\partial x} - \int_o^s \frac{\partial^2 T}{\partial x^2} ds = \int_s^A \frac{\partial^2 T}{\partial x^2} ds \text{ when } S_A = 0$$

let  $p$  = longitudinal stress

then  $T = tp$

All the above are assumed to have cosine distribution in  $x$  direction, of the form  $\cos ax$ , where  $a = n\pi/l$ , to correspond with terms of the Fourier Series. When the above are the values at the centre

$$\frac{\partial^2 p}{\partial x^2} = -a^2 p$$

As before, the applied forces at O are  $X = \{X_1 X_2 X_3 X_4\}$

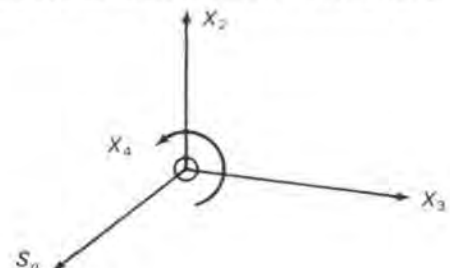

On a strip of unit width we have a lateral force of  $\frac{\partial S}{\partial x}$ :

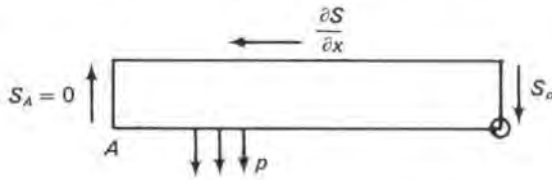

Thus

$$X_1 = \frac{\partial S_o}{\partial x} = \int_0^A \frac{\partial^2 T}{\partial x^2} ds = -a^2 \int_0^A t p ds$$

$$X_2 = \int_0^A \frac{\partial S}{\partial x} \sin \phi ds = \int_0^A \frac{\partial S}{\partial x} dz \text{ since } \sin \phi = \frac{\partial z}{\partial s}$$

$$= \int_0^A \left[ z \frac{\partial S}{\partial x} \right] - \int_0^A z \frac{\partial^2 S}{\partial x \partial s} ds$$

The first term goes out because  $\frac{\partial S}{\partial x} = 0$  at A and  $z = 0$  at O

From (1)  $\frac{\partial^2 S}{\partial x \partial s} = -\frac{\partial^2 T}{\partial x^2}$

$$\therefore X_2 = \int_0^A z \frac{\partial^2 T}{\partial x^2} ds = -a^2 \int_0^A z t p ds$$

$$X_3 = \int_0^A \frac{\partial S}{\partial x} \cos \phi ds = \int_0^A \frac{\partial S}{\partial x} dy$$

$$= \int_0^A \left[ y \frac{\partial S}{\partial x} \right] - \int_0^A y \frac{\partial^2 S}{\partial x \partial s} ds$$

$$= \int_0^A y \frac{\partial^2 T}{\partial x^2} ds = -a^2 \int_0^A y t p ds$$

For torsion in this section we use same convention as before:

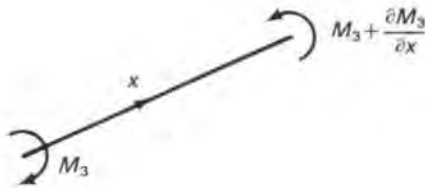

$$X_4 = -\frac{\partial M_3}{\partial x} + \int_0^A r \frac{\partial S}{\partial x} ds$$

$$= -\frac{\partial M_3}{\partial x} + \int_0^A r \left\{ \int_0^s \frac{\partial^2 T}{\partial x^2} ds \right\} ds$$

$$= -\frac{\partial M_3}{\partial x} + \int_0^A \frac{\partial^2 T}{\partial x^2} \left\{ \int_0^s r ds \right\} ds *$$

$$= -\frac{\partial M_3}{\partial x} - a^2 \int_0^A \xi t p ds$$

where  $\xi = \int_0^s r ds$

\*The proof of this requires a separate account.

When  $\phi$  and  $\psi$  are any function of  $s$ , with the following boundary values;

let  $\bar{\phi} = \int_0^s \phi ds$

where  $\bar{\phi}_0 = 0$

so that  $d\bar{\phi} = \phi ds$

let  $\bar{\psi} = \int_s^A \psi ds$

where  $\bar{\psi}_A = 0$

so that  $\bar{\psi}_0 = \int_0^A \psi ds$

i.e.  $\bar{\psi} = \bar{\psi}_0 - \int_0^s \psi ds$

$d\bar{\psi} = -\psi ds$

The special property of the section  $\xi = \int_0^s r ds$  is the key. It is best plotted along the section. In the three-sided example the diagram would be

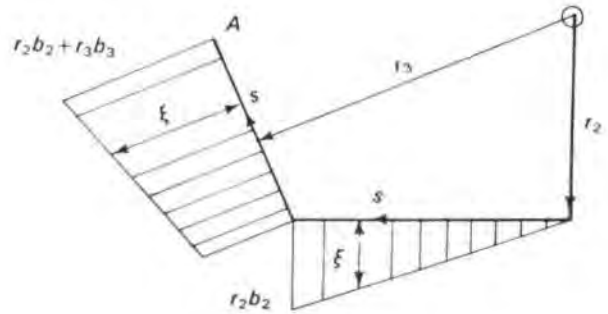

As a preliminary to finding the required force-displacement relation, we deal with the torsional stresses. It is assumed that when the O point rotates through a small angle  $\theta$ , the whole section rotates by this amount.

(See notes at end on torsion in thin sections.)

$$M_3 = \frac{E}{6(1+\sigma)} \frac{\partial \theta}{\partial x} \int_0^A t^3 ds \text{ in example}$$

generally:  $M_3 = \frac{E}{6(1+\sigma)} \frac{\partial \theta}{\partial x} \int_0^A t^3 ds$

let  $I_3 = \frac{1}{6(1+\sigma)} \int_0^A t^3 ds$

then  $\frac{\partial M_3}{\partial x} = E I_3 \frac{\partial^2 \theta}{\partial x^2} = I_3 U_a$

( $\sigma$  is Poisson's ratio)

The edge effect is sometimes taken into account by assuming that the section stops  $t/3$  short of actual edge. Of course,  $I_3$  would be quite different if the edge beam were a closed box section.

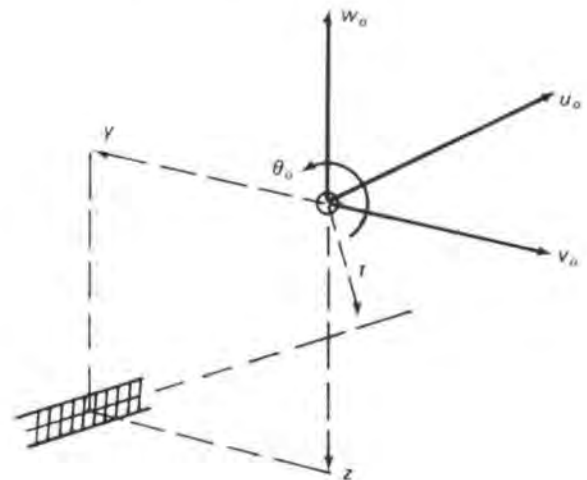

The expression

$$F = \int_0^A \phi \left\{ \int_0^s \psi ds \right\} ds$$

$$= \int_0^A \phi \bar{\psi} ds = \int_0^A \bar{\psi} d\bar{\phi}$$

$$= \int_0^A \left[ \bar{\phi} \bar{\psi} \right] - \int_0^A \bar{\phi} d\bar{\psi}$$

the first term goes out because  $\bar{\phi}_0 = 0$  and  $\bar{\psi}_A = 0$ , so that, since  $d\bar{\psi} = -\psi ds$

$$F = \int_0^A \bar{\psi} \bar{\phi} ds = \int_0^A \bar{\psi} \left\{ \int_0^s \phi ds \right\} ds$$

Consider longitudinal stress at a point on middle surface of beam due to the four junction point displacements, taken one at a time.

(1) Due to  $u_o: u = u_o$

$$\therefore p = E \frac{\partial u_o}{\partial x} = U_1$$

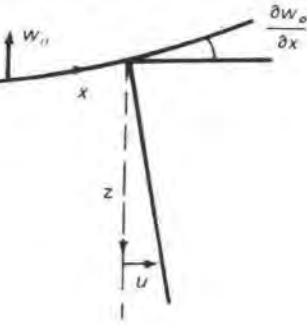

(2) Due to  $w_o: u = z \frac{\partial w_o}{\partial x}$

$$\frac{\partial u}{\partial x} = z \frac{\partial^2 w_o}{\partial x^2}$$

$$\therefore p = zE \frac{\partial^2 w_o}{\partial x^2} = zU_2$$

(3) Due to  $v_o: u = y \frac{\partial v_o}{\partial x}$

$$\therefore p = yE \frac{\partial^2 v_o}{\partial x^2} = yU_3$$

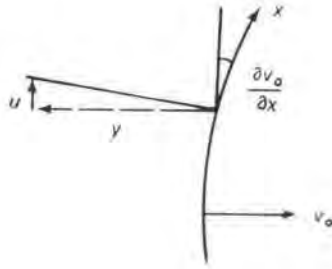

(4) Due to  $\theta_o:$

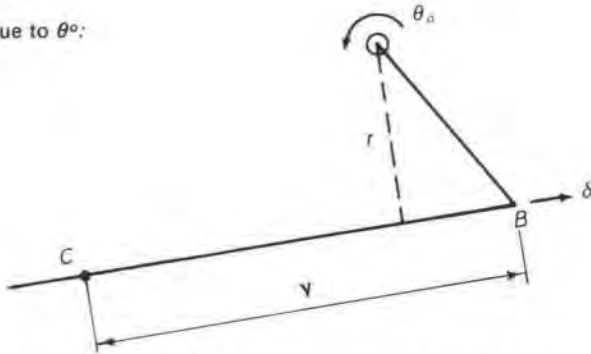

In the above case, the point B is unstressed, but moves in direction CB by  $\delta = r\theta_o$ .

$$\therefore u = r \frac{\partial \delta}{\partial x} = yr \frac{\partial \theta_o}{\partial x}$$

$$\therefore \frac{\partial u}{\partial x} = yr \frac{\partial^2 \theta_o}{\partial x^2}$$

$$\therefore p = yrE \frac{\partial^2 \theta_o}{\partial x^2} = yrU_4$$

$$\text{now } yr = r \int_B^C dy = r \int_B^C ds = r \int_0^s ds$$

because  $r = 0$  from O to B.

When  $r$  varies, it is not difficult to see that the last expression applies.

$$\therefore p = U_4 \int_0^s r ds = \xi U_4$$

Thus we have complete expression for longitudinal stress, due to  $U \equiv \{U_1, U_2, U_3, U_4\}$

$$p = U_1 + zU_2 + yU_3 + \xi U_4$$

By substituting  $p$  in previous expressions for  $X \equiv \{X_1, X_2, X_3, X_4\}$  we obtain the relation

$$X = -GU$$

The integrations are over whole edge beam profile,  $\int_0^A$

$$G = \begin{bmatrix} a^2 \int t ds & a^2 \int z t ds & a^2 \int y t ds & a^2 \int \xi t ds \\ a^2 \int z t ds & a^2 \int z^2 t ds & a^2 \int z y t ds & a^2 \int z \xi t ds \\ a^2 \int y t ds & a^2 \int z y t ds & a^2 \int y^2 t ds & a^2 \int y \xi t ds \\ a^2 \int \xi t ds & a^2 \int z \xi t ds & a^2 \int y \xi t ds & I_3 + a^2 \int \xi^2 t ds \end{bmatrix}$$

The components of the leading  $3 \times 3$  submatrix are the ordinary expressions – area, first and second moments of area – for a beam.

The components of the last row and column have now been given completely for the first time.

It is clear that a rotational transformation can be applied to the G matrix, because  $r$  is unchanged. The translational transformation will be dealt with later.

We now consider some examples for the terms involving  $\xi = \int_0^s r ds$ .

When  $\int_0^A z \xi t ds$  and  $\int_0^A y \xi t ds$  are zero, the O point coincides with the shear centre of the edge beam, under certain conditions.

An obvious example of this case is an angle meeting at O, because  $r$  is zero everywhere.

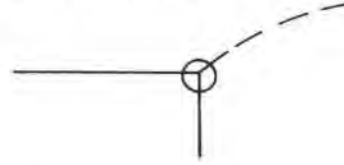

Consider a channel section thus:

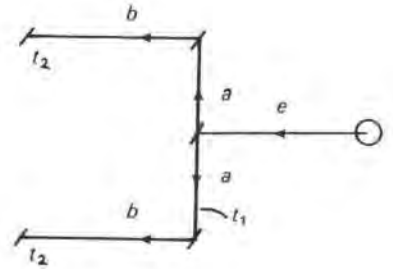

The  $\xi$  diagram is:

$$\xi = \int_0^s r ds$$

By symmetry:

$$\int_0^A t \xi ds = 0$$

$$\int_0^A y t \xi ds = 0$$

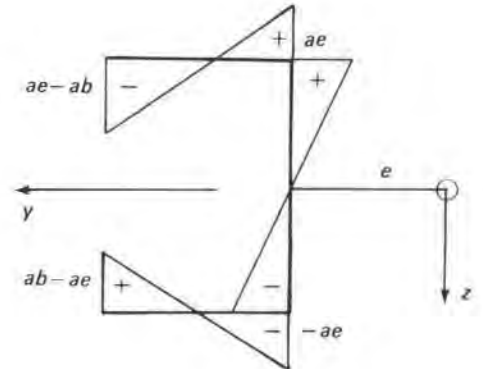

The  $z\xi$  diagram is:

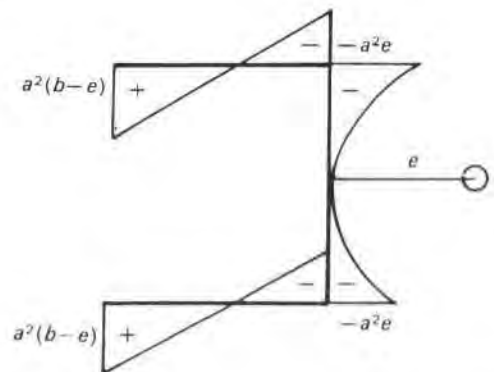

$$\int_0^A z t \xi ds = -\frac{2}{3} a^3 e t_1 + b \{ a^2 (b-e) - a^2 e \} t_2 = a^2 \{ b^2 t_2 - \frac{2}{3} a e t_1 - 2 b e t_2 \}$$

$$\text{when } \int_0^A z t \xi ds = 0: e = \frac{b}{2 \left( 1 + \frac{a t_1}{3 b t_2} \right)}$$

which gives shear centre of channel.

In the preceding we have dealt with a thin section edge beam with a shell connected to one edge, the other edge or edges being free.

When the other edge is connected to another shell a translational transformation is required.

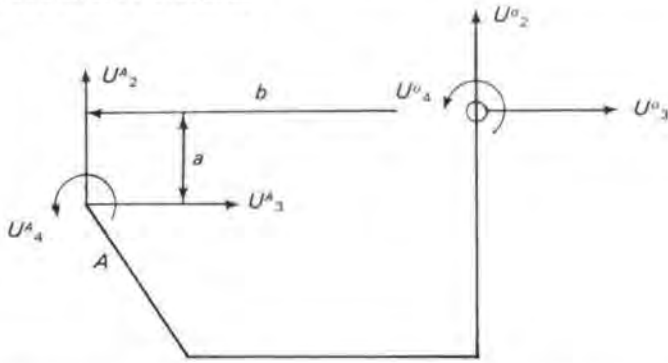

We have already set up the displacement transformation from  $O$  to  $A$  in the investigation of longitudinal stress:

$$\begin{aligned} U_1^A &= p_A = U_1^0 + aU_2^0 + bU_3^0 + \xi_A U_4^0 \\ U_2^A &= U_2^0 - bU_4^0 \\ U_3^A &= U_3^0 + aU_4^0 \\ U_4^A &= U_4^0 \end{aligned}$$

where  $\xi_A = \int_0^A r ds$ .

Thus putting  $U^A = H'U^O$  we should expect  $X^O = HX^A$  by contra-gredience

i.e.

$$\begin{bmatrix} X_1^O \\ X_2^O \\ X_3^O \\ X_4^O \end{bmatrix} = \begin{bmatrix} 1 & & & \\ a & 1 & & \\ b & & 1 & \\ \xi_A & -b & a & 1 \end{bmatrix} \begin{bmatrix} X_1^A \\ X_2^A \\ X_3^A \\ X_4^A \end{bmatrix}$$

In this it is apparent that the path of the translation must be taken into account.

The only part that calls for comment is the last row:

$$X_4^O = \xi_A X_1^A - bX_2^A + aX_3^A + X_4^A$$

If, on page 4, had we assumed a shear stress,  $S_A$ , at the free edge, we should have found the following added to our expressions:

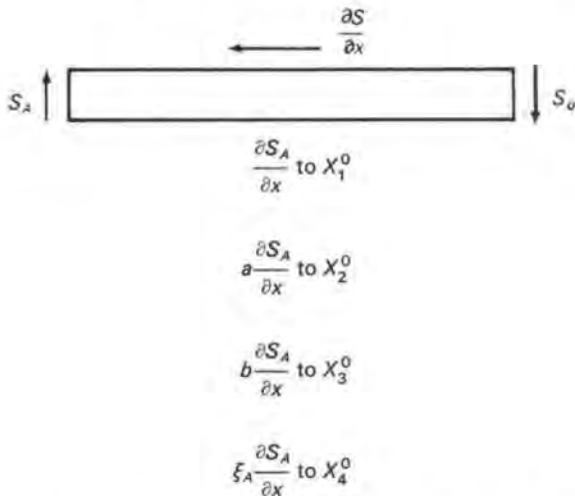

The transformation means that an action  $X^A$  at  $A$  is statically equivalent to an action  $X^O = HX^A$  at  $O$ .

In the applied force transformation the beam is assumed to be unstrained; hence  $M_3$  is absent, and  $S$  is constant, i.e.  $S_A = S_o = S$ .

As  $S_A$  has a sine distribution, it is clear that  $r \frac{\partial S}{\partial x}$  adds another component to  $X_4^O$  amounting to

$$+ \frac{\partial S_A}{\partial x} \int_0^A r ds$$

Hence in this respect

$$X_4^O = + \xi_A \frac{\partial S_A}{\partial x} = \xi_A X_1^A$$

Thus a translational transformation means a translation along the path of the profile of the edge beam.

When there are shells connected to edges  $O$  and  $A$ , we must make a transformation so as to deal with the whole junction at  $O$ , say. The steps are set out in the usual manner as follows:

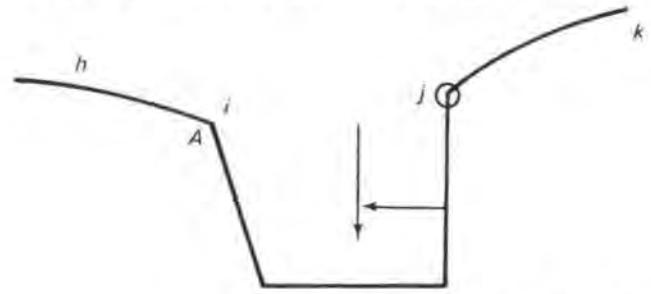

|                             | Shell $ih$   | Beam $ij$  | Shell $jk$   |
|-----------------------------|--|--|--|
| Particular integral:        | $\bar{x}_{ih}^0$<br>$\bar{u}_{ih}^0$                       | $X_{ij}^0$<br>Load and moment                        | $\bar{x}_{jk}^0$<br>$\bar{u}_{jk}^0$                       |
| Remove displacements:       | $\bar{x}_{ih}^{(1)} = J\bar{G}_{ih}J\bar{u}_{ih}^0$        |  | $\bar{x}_{jk}^{(1)} = -\bar{G}_{jk}\bar{u}_{jk}^0$         |
| Total edge stresses:        | $\bar{y}_{ih}^{(1)} = \bar{x}_{ih}^0 + \bar{x}_{ih}^{(1)}$ |  | $\bar{y}_{jk}^{(1)} = \bar{x}_{jk}^0 + \bar{x}_{jk}^{(1)}$ |
| Transformations to actions: | $Y_{ih}^{(1)} = -JO_{ih}J\bar{y}_{ih}^{(1)}$               |  | $Y_{jk}^{(1)} = O_{jk}\bar{y}_{jk}^{(1)}$                  |
| Transformation to $j$ :     | $Y_{ij}^{(1)} = HY_{ih}^{(1)}$                             |  |  |
| Total action at $j$ :       |  | $Y_j^{(1)} = Y_{ij}^{(1)} + X_{ij}^0 + Y_{jk}^{(1)}$ |  |

In the above,  $O$  means rotational transformation at junction;  $H$  means translational transformation across edge beam.

To find the junction displacement we have to transform stiffness of shell  $hi$  to junction  $j$ .

Shell  $G_A = JO_{ih}\bar{G}_{ih}O'_{ih}J$   
 From  $X_A = -G_A U_A$   
 $X_o = HX_A = -HG_A H'U_o$   
 $\therefore G_{ih} = -HG_A H'$   
 $\therefore G_j = G_{ih} + G_{ij} + G_{jk}$

Junction displacement:  $U_j^{(1)} = -G_j^{-1}Y_j^{(1)}$

Displacement of point  $i$ :  $U_i^{(1)} = H'U_j^{(1)}$

Net edge displacements:

$$\bar{u}_{ih}^{(1)} = JO'_{ih}JU_i^{(1)} - \bar{u}_{ih}^0 \quad \bar{u}_{jk}^{(1)} = O'_{jk}U_j^{(1)} - \bar{u}_{jk}^0$$

### Second stage: repeat

In the above,  $O$  is a rotational transformation at shell edge, and  $H$  is beam transformation already given.

### Detail design of edge beam

At the end of the distribution we shall have the total displacement of the  $O$  point,  $U_o = U_j$ . We shall also have the action at  $i$  (statically equivalent to the internal stresses at the edge of shell  $ih$ ), the loads on the beam, and the action at  $j$  (statically equivalent to the internal stresses at the edge of shell  $jk$ ).

The equivalent action on the beam

$$X_o = HX_i + X_{ij}^0 + X_j$$

These should check with the displacement

$$X_o = -G_{ij}U_o$$

The longitudinal stresses may be plotted from

$$\rho = U_1 + zU_2 + yU_3 + \xi U_4$$

and hence the shear stress diagram from

$$\frac{\partial S}{\partial x} = \frac{\partial S_o}{\partial x} + a^2 \int_0^S ptds$$

where  $\frac{\partial S_o}{\partial x} = X_1^j$  final at  $O$

and this should check

$$X_1^j = -\frac{\partial S_A}{\partial x} = -X_1^i - a^2 \int_0^A ptds$$

From the  $\frac{\partial S}{\partial x}$  diagram we proceed to find the transverse bending as follows:

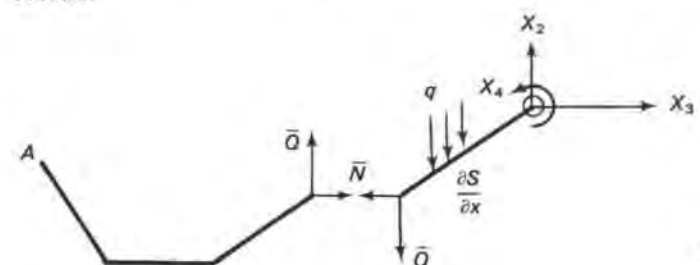

Let  $q$  = load per unit  $s$ , on edge beam itself.

$$\bar{Q} = X_2 - \int_0^s \frac{\partial S}{\partial x} \sin \phi \, ds - \int_0^s q \, ds$$

$$\bar{N} = X_3 - \int_0^s \frac{\partial S}{\partial x} \cos \phi \, ds$$

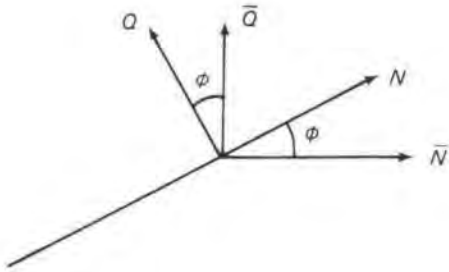

$$Q = \bar{Q} \cos \phi - \bar{N} \sin \phi$$

$$N = \bar{N} \sin \phi + \bar{Q} \cos \phi$$

Equation of equilibrium:

$$\frac{\partial H}{\partial x} + \frac{\partial M}{\partial s} + Q = 0$$

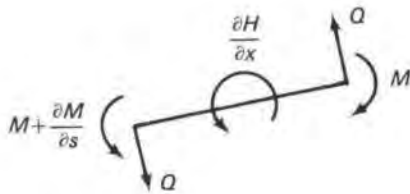

$$\therefore M = -X_4 - \int_0^s Q \, ds - 2 \int_0^s \frac{\partial H}{\partial x} \, ds *$$

$$= -X_4 - \int_0^s Q \, ds - \frac{\int_0^s t^3 \, ds}{\int_0^A t^3 \, ds} \frac{\partial M_3}{\partial x}$$

This should check with

$$M_A = X_4^I = -X_4^I - \int_0^A Q \, ds - \frac{\partial M_3}{\partial x}$$

It is a simple matter to show that  $\int_0^A Q \, ds = - \int_0^A r \frac{\partial S}{\partial x} \, ds$  for an un-

loaded beam (without  $q$ ), thus verifying expression.

When

$$M_A = 0, X_4^I = - \frac{\partial M_3}{\partial x} + \int_0^A r \frac{\partial S}{\partial x} \, ds$$

because

$$\int_0^A Q \, ds = \int_0^A \bar{Q} \cos \phi \, ds - \int_0^A \bar{N} \sin \phi \, ds$$

$$= \int_0^A \left[ y \bar{Q} \right] - \int_0^A y \frac{\partial \bar{Q}}{\partial s} \, ds - \int_0^A \left[ z \bar{N} \right] + \int_0^A z \frac{\partial \bar{N}}{\partial s} \, ds$$

$$= \int_0^A y \sin \phi \frac{\partial S}{\partial x} \, ds - \int_0^A z \cos \phi \frac{\partial S}{\partial x} \, ds = - \int_0^A r \frac{\partial S}{\partial x} \, ds$$

### Notes on torsional rigidity of thin sections

The relation between torsion and twist per unit distance in a plate is

$$H = \frac{EI}{1 + \sigma} \frac{\partial^2 w}{\partial x \partial s} \text{ where } \sigma = \text{Poisson's ratio.}$$

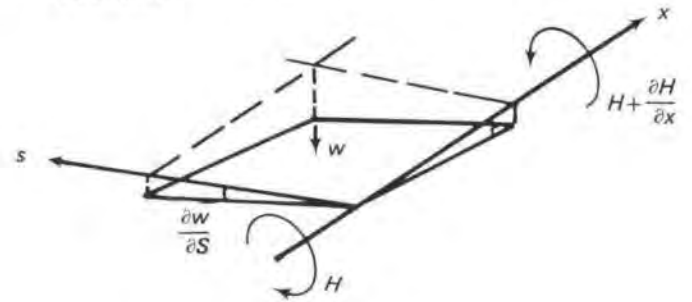

$$\text{When } \theta = \frac{\partial w}{\partial s}, H = \frac{EI}{1 + \sigma} \frac{\partial \theta}{\partial x} \text{ where } I = \frac{t^3}{12}$$

The shear stress distribution over the thickness of the plate is assumed to be linear:

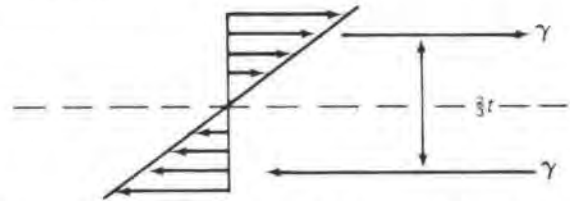

and is equivalent to a pair of equal and opposite shear forces given

$$\text{by } H = \frac{2t}{3} \tau, \text{ i.e. } \tau = \frac{3H}{2t}$$

In a thin plate of finite width, twisting as a whole, the shear stress flow approximates to a linear distribution in two directions:

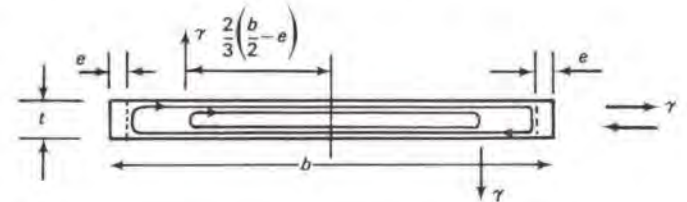

so that the total stress couple =

$$(b - 2e) \frac{2}{3} t \tau + t \frac{2}{3} (b - 2e) \tau = 2H(b - 2e)$$

$e$  is a reduction of effective width to allow for edge effect. Experiments show that  $e = 0.32t$  for light alloy.

The return of stress flow thus nearly doubles the applied couple, and the effect is equivalent to a normal edge force of  $H$  on a plate of width  $= b - 2e$ .

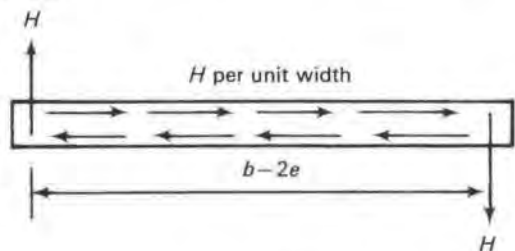

$$M_3 = 2H(b - 2e) = \frac{Et^3}{6(1 + \sigma)} (b - 2e) \frac{\partial \theta}{\partial x}$$

We can also imagine that the plate is made up of a number of narrow plates of unit width, with no edge reduction between each narrow plate:

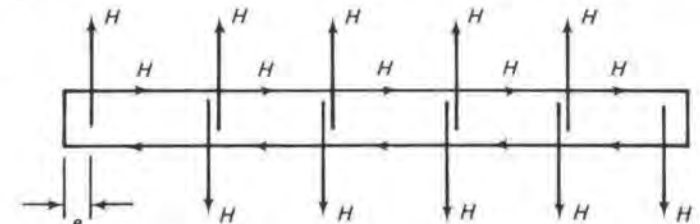

The normal forces cancel at each junction.



This simile makes it a simple matter to deal with a thin open section:

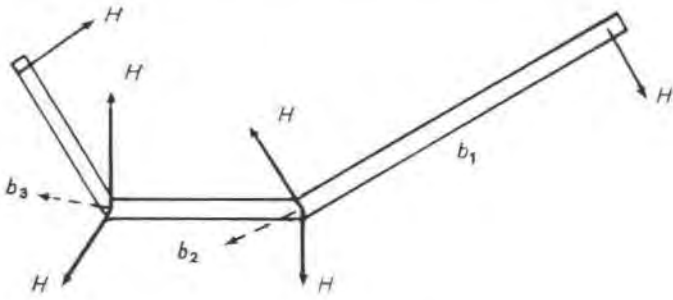

The effect of the 'surplus' shear stress at corners is:

$$M_3 = 2(b_1 - e)H + 2b_2H + 2(b_3 - e)H = 2H(b_1 + b_2 + b_3 - 2e)$$

that is, the same as a flat plate of same developed width.

We now assume that the edge reduction  $e$  is automatically taken into account, that is, the widths  $b$  are effective widths.

With a sudden change in plate thickness we assume:

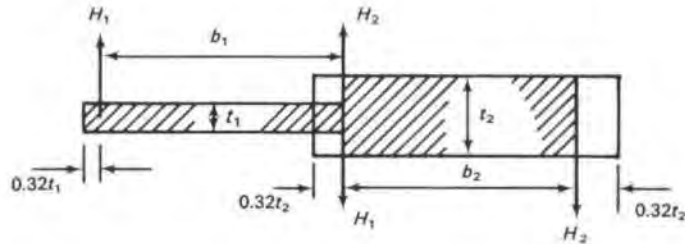

$$H_1 = \frac{Et_1^3}{12(1+\sigma)} \frac{\partial \theta}{\partial x} \quad H_2 = \frac{Et_2^3}{12(1+\sigma)} \frac{\partial \theta}{\partial x}$$

$$M_3 = 2H_1b_1 + 2H_2b_2 = \frac{E}{6(1+\sigma)} \frac{\partial \theta}{\partial x} \{b_1t_1^3 + b_2t_2^3\}$$

and so generally

$$M_3 = \frac{E}{6(1+\sigma)} \frac{\partial \theta}{\partial x} \int t^3 ds$$

where  $s$  is measured along middle surface of plate.

In point of fact, rounded corners add to the rigidity, and the following are some empirical rules for light alloy:

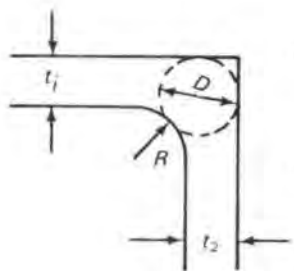

$$h = \frac{t_2}{t_1} \text{ or } \frac{t_1}{t_2} \text{ (less than 1).}$$

$$\text{Add: } \frac{E}{6(1+\sigma)} \frac{\partial \theta}{\partial x} h \left( 0.21 + 0.224 \frac{R}{t_1} \right) D^4$$

where  $t_1$  is thicker leg.

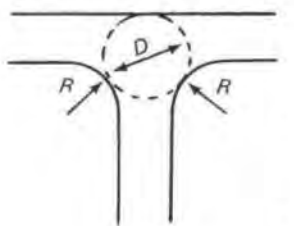

$$\text{Add: } \frac{E}{6(1+\sigma)} \frac{\partial \theta}{\partial x} h \left( 0.45 + 0.3 \frac{R}{t_1} \right) D^4$$

where  $t_1$  is thicker leg.

When  $M_3$  varies in the  $x$  direction there must be an applied transverse couple. As in shells, when there is a term  $\frac{\partial H}{\partial x}$ , we have, to

maintain equilibrium, to make use of the Kirchhoff boundary hypothesis that the resultant normal shear force at an edge is  $R = Q - \frac{\partial H}{\partial x}$  where  $Q$  is the normal shear force near the boundary.

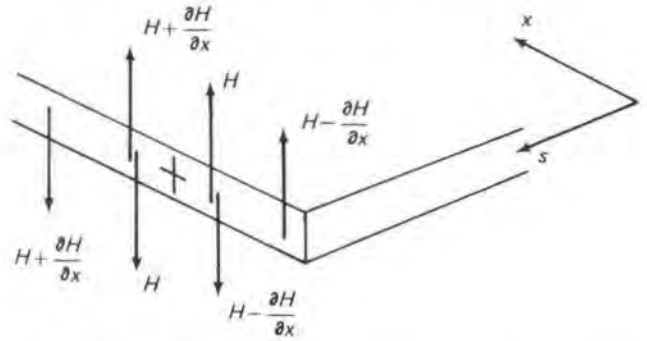

When the diagram is for a free edge,  $R = 0$ , so that in the absence of other loads applied to the plate there exists a normal shear

$$Q = \frac{\partial H}{\partial x}$$

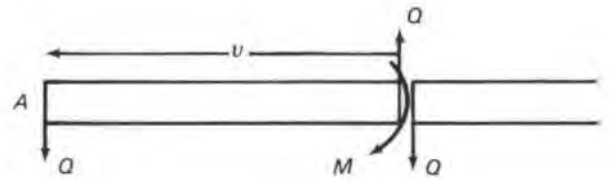

Thus from the equation of equilibrium of a unit square at  $y$  from the edge,  $\frac{\partial H}{\partial x} + \frac{\partial M}{\partial s} + Q = 0$ .

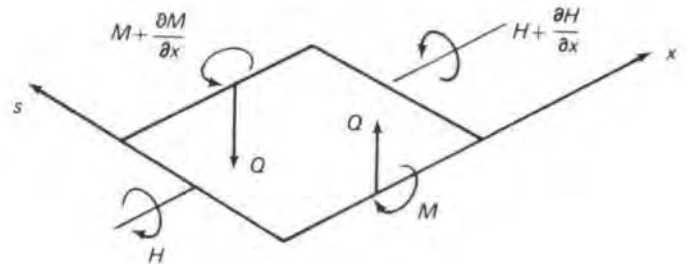

$$M = - \int_s^A \frac{\partial H}{\partial x} ds - \int_s^A Q ds = -2 \int_s^A \frac{\partial H}{\partial x} ds$$

This comes to the same thing as taking into account the return of stress flow at the edge of a unit width transverse strip:

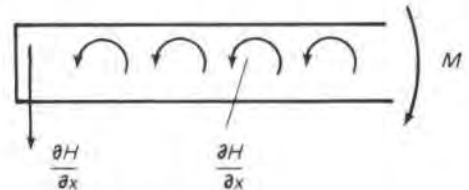

and confirms the method of finding the transverse moment in a thin section edge beam which does not change its shape.

It is not suggested that the material given in the preceding should be used in this way to find the shear centres of thin section beams. The channel example happened to come out correctly because the link was joined to the neutral axis for vertical loads.

The shear centre is defined as follows:

When a lateral load in any direction passes through the shear centre,  $\int r_1 \frac{\partial S}{\partial x} = 0$ ,  $r_1$ , being measured from this shear centre. When the lateral load does not pass through this point, the applied twisting couple is the load multiplied by its perpendicular distance from the shear centre.

Thus, in our terminology, when the only applied forces are  $X_2$  and  $X_3$ , we have

$$\frac{\partial M_3}{\partial x} = \int_0^A r \frac{\partial S}{\partial x} ds \quad (\text{because } r \text{ is from point of applied loads})$$

$$X_2 = \int_0^A \frac{\partial S}{\partial x} \sin \phi ds$$

$$X_3 = \int_0^A \frac{\partial S}{\partial x} \cos \phi ds$$

now  $r = z \cos \phi - y \sin \phi$ .

Let the shear centre be at  $(\bar{y}, \bar{z})$  and let the co-ordinates measured from the shear centre be  $(y_1, z_1)$ , so that  
 $z = \bar{z} + z_1$   
 $y = \bar{y} + y_1$

$$\begin{aligned} \frac{\partial M_3}{\partial x} &= \int_0^A z \cos \phi \frac{\partial S}{\partial x} ds - \int_0^A y \sin \phi \frac{\partial S}{\partial x} ds \\ &= \bar{z} \int_0^A \frac{\partial S}{\partial x} \cos \phi ds - \bar{y} \int_0^A \frac{\partial S}{\partial x} \sin \phi ds \\ &+ \int_0^A z_1 \cos \phi \frac{\partial S}{\partial x} ds - \int_0^A y_1 \sin \phi \frac{\partial S}{\partial x} ds \\ &= \bar{z} X_3 - \bar{y} X_2 + \int_0^A r_1 \frac{\partial S}{\partial x} ds \end{aligned}$$

where, by definition,

$$\int_0^A r_1 \frac{\partial S}{\partial x} ds = 0.$$

In the case of shell edge beams, the question of shear centre is so complicated that it is better to have nothing to do with it, but to use the simply derived  $G$  matrix.

## Prestressed thin section edge beams

To be read in conjunction with the previous note on thin section edge beams.

To introduce the ideas we will deal, first, with the ordinary vertical edge beam treated in Chapter 6 of the original book.

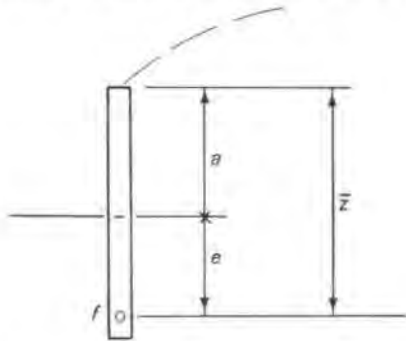

$f$  = the total prestress centred at  $e$  below neutral axis. Due to the prestress alone on the edge beam alone

$$F = -f$$

$$M_1 = -ef$$

On page 42 of the book we see that due to applied forces  $X_1$  and  $X_2$  on edge beam alone

$$F = -\frac{1}{a^2} X_1$$

$$M_1 = -\frac{1}{a^2} (X_2 - aX_1)$$

We can find the values of  $X_1$  and  $X_2$  which leave no resultant  $F$  and  $M_1$  in the edge beam, by

$$f + \frac{1}{a^2} X_1 = 0$$

$$ef + \frac{1}{a^2} (X_2 - aX_1) = 0$$

i.e.

$$X_1 = -a^2 f$$

$$X_2 = -a^2(a+e)f = -a^2 \bar{z} f$$

$X_2$  is a downward applied force, as we would expect. The actions (particular integral) at the undisplaced edge due to the prestress alone are the reverse of the above.

Thus the initial actions at the junctions, called the particular integral, due to the prestress alone are

$$Y_1 = a^2 f$$

$$Y_2 = a^2 \bar{z} f \text{ (upward)}$$

These results can be obtained directly, and this will lead to the general thin section edge beam treatment.

In the above it is assumed that the cable force is  $f$  at the centre and falls off in the  $x$  direction according to the cosine function of the first term of the Fourier series.

$$f^x = f \cos ax$$

To find the particular integral, we are investigating a state when certain forces are applied to the edge beam to relieve the concrete of all direct stress.

In this condition, equations of equilibrium may be set up relating prestress with applied edge forces.

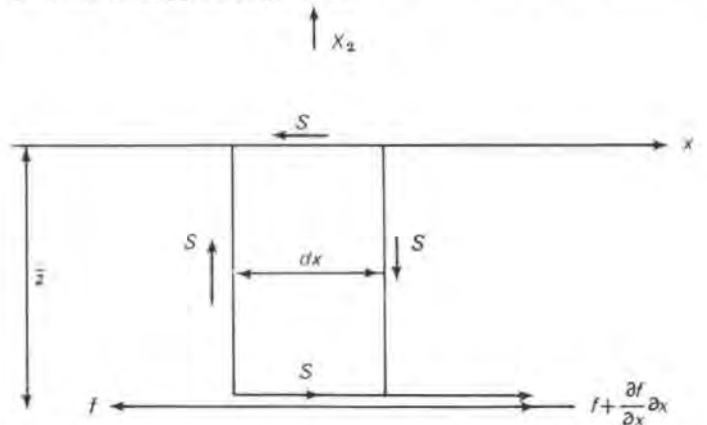

A stopped-off cable (or part of a cable) induces a shear stress in depth of edge beam from junction to cable position, of

$$S = \frac{\partial f}{\partial x}$$

In the diagram, the shear is in 'opposite' direction. Thus the applied forces are

$$X_1 = \frac{\partial S}{\partial x} = \frac{\partial^2 f}{\partial x^2} = -a^2 f$$

$$X_2 = \bar{z} \frac{\partial S}{\partial x} = -a^2 \bar{z} f$$

So that the required particular integrals are

$$Y_1 = a^2 f$$

$$Y_2 = a^2 \bar{z} f$$

We now use this method for

### (1) Prestressed thin section edge beam with straight cables stopped off

Let  $\bar{y}$ ,  $\bar{z}$ ,  $\bar{s}$  and  $\bar{\xi}$  refer to the position of a given cable:  
i.e.

$$\bar{\xi} = \int_0^{\bar{e}} r ds$$

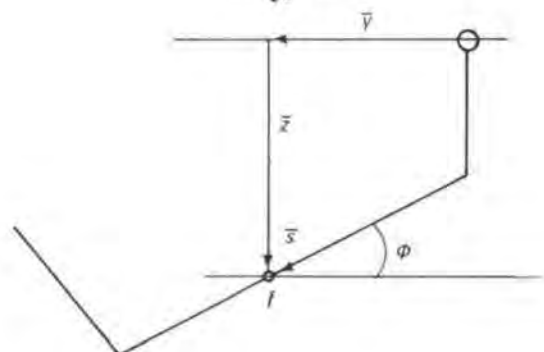

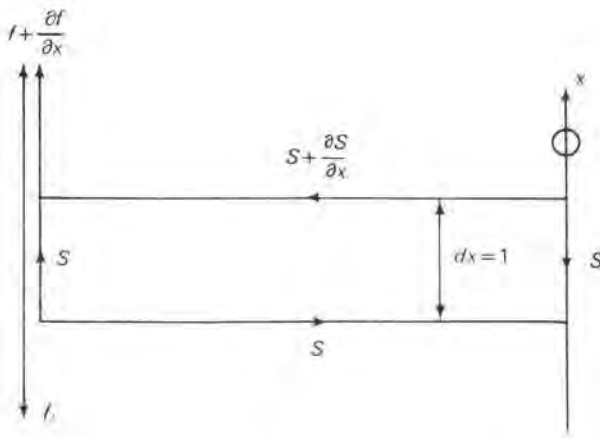

$$S = \frac{\partial f}{\partial x} \text{ (constant in } s \text{ from } 0 \text{ to } \bar{s})$$

$$Y_1 = -X_1 = -\frac{\partial S}{\partial x} = a^2 f$$

$$Y_2 = -\frac{\partial S}{\partial x} \int_0^{\bar{s}} \sin \phi \, ds = a^2 \bar{z} f$$

$$Y_3 = -\frac{\partial S}{\partial x} \int_0^{\bar{s}} \cos \phi \, ds = a^2 \bar{y} f$$

$$Y_4 = -\frac{\partial S}{\partial x} \int_0^{\bar{s}} r \, ds = a^2 \bar{\xi} f$$

So that for all the cables:

$$Y_1 = a^2 \Sigma f$$

$$Y_2 = a^2 \Sigma \bar{z} f$$

$$Y_3 = a^2 \Sigma \bar{y} f$$

$$Y_4 = a^2 \Sigma \bar{\xi} f$$

If we wanted to find the displacements of such a beam, prestressed in this way, we could do so by using

$$X = -G_B U \text{ where } X = Y$$

(that is, removing initial applied forces with  $G_B$  as given in previous note).

However, this information is not required when dealing with a prestressed edge beam to a shell.

This case (1) with stopped-off cables is somewhat idealized. We must, therefore, arrive at some approximations to deal with more practical cable arrangements.

### (2) Approximation for uniformly prestressed edge beam

For this case it is assumed that all the cables go right through and their positions are so arranged that the edge beam alone is in a state of uniform compression due to the prestress alone.

Let  $F = \Sigma f$  = total amount of prestress compression,  $p = \frac{F}{\int_0^A t \, ds}$

(constant).

To approximate this rectangular distribution in  $x$ , to a cosine shape,

we introduce the usual  $\frac{4}{\pi}$  factor

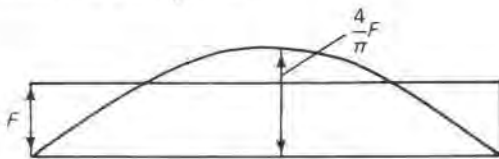

Either from case (1), or from the previous note we have particular integrals:

$$Y_1 = \frac{4}{\pi} a^2 F \left( = \frac{4}{\pi} a^2 p \int_0^A t \, ds \right)$$

$$Y_2 = \frac{4}{\pi} a^2 p \int_0^A z t \, ds$$

$$Y_3 = \frac{4}{\pi} a^2 p \int_0^A y t \, ds$$

$$Y_4 = \frac{4}{\pi} a^2 p \int_0^A \xi t \, ds$$

where  $p$  is taken as positive.

### (3) Approximation for curved cables

Here it is assumed that the end anchorages are as in case (2) (uniform compression at ends), but that some of the cables are displaced by curving them.

If a cable is displaced a maximum of  $e$  from its anchorage position in the direction of  $s$ :

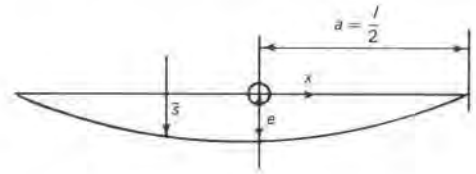

$$\text{For a parabolic cable, } \frac{\partial^2 \bar{s}}{\partial x^2} = -\frac{2e}{a^2}$$

This cable exerts a uniform lateral force of  $\frac{2e}{a^2} f$

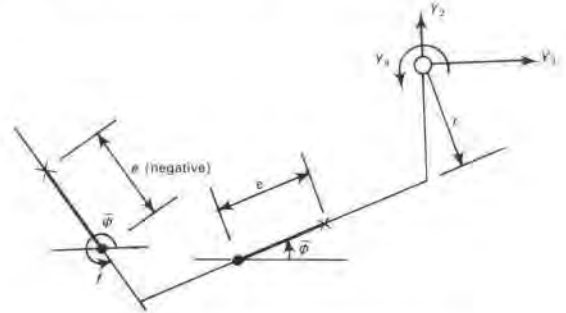

So that we must add to case (2) the following

$$Y_2 = \frac{4}{\pi} \frac{2}{a^2} \Sigma e f \sin \bar{\phi} \approx a^2 \Sigma e f \sin \bar{\phi}$$

$$Y_3 = \frac{4}{\pi} \frac{2}{a^2} \Sigma e f \cos \bar{\phi} \approx a^2 \Sigma e f \cos \bar{\phi}$$

$$Y_4 = \frac{4}{\pi} \frac{2}{a^2} \Sigma e f \bar{r} \approx a^2 \Sigma e f \bar{r}$$

(Note that  $e$  means cable displacement.)

In the upturned back leg  $e$  will usually be reversed and therefore negative.

The last expressions after the  $\approx$  sign are what would be obtained for a cosine curved cable, and as would be expected, are very little different from a parabolic cable.

Thus, in general, the particular integral for a prestressed edge beam will be divided into two parts:

(1) Case (1) assuming the cables go straight from anchorage to anchorage. If all the cables go right through use the  $4/\pi$  factor. If some of the cables are stopped-off or run out between the ends, use a factor between  $4/\pi$  and unity, according to how closely the total prestress approximates to a cosine curve.

(2) Case (3) for any curved cables. For sudden changes in direction we must assume that the lateral forces, so induced, are spread uniformly from end to end. If a curved cable runs out to anchorages not at the ends we must use our judgment:

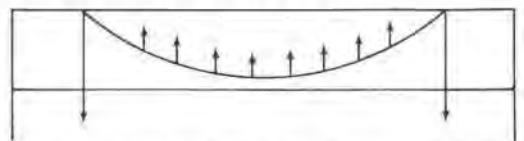

In this case there is no resultant lateral force because that at the anchorages equals the sum between. However, if the anchorages are near the ends the net result will be an upward lateral force. Perhaps this could be dealt with by assuming the net lateral force gives the same bending moment at the centre, considered as a beam.

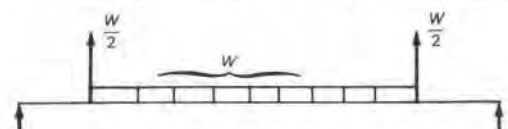

It should be noted that if the shell itself is uniformly prestressed longitudinally to the same intensity as the edge beam, the most approximate component of the particular integral for prestress alone, namely  $X_1$ , disappears. This uniform longitudinal stress would then have to be added at the finish of the calculations.

Ronald Jenkins then developed the use of matrix algebra in linear structural analysis along two different paths, where the use of matrices arose naturally for two rather different reasons.

The first path lay in the field of the analysis of skeletal structures and led to his paper Matrix analysis applied to statically indeterminate structures: 1953; which was his definitive statement on what is now known as the flexibility (or force) method of analysis. This paper was never published although shortened versions appeared later in a note published by the Euler Society in 1954 and in his Taylor Woodrow Foundation Lectures, 1961. However, the ideas contained in it were disseminated widely, as the influence coefficient method, notably through John Henderson at Imperial College and by Peter Morice at Southampton University and had a profound effect on the thinking of structural analysts. This paper is printed here in full, partly for its historical interest, partly because it is still practically relevant and partly for the intrinsic, almost aesthetic, interest of the logical development from a single idea to a complete branch of analysis.

The starting point for his thinking was the work of Ostenfeld on indeterminate structures whereby the structure was made statically determinate by introducing appropriate releases; values of the actions (such as bending moment or shear force) were chosen so that their effect, in conjunction with that of the external load, restored compatibility of deformation at the releases. Ronald Jenkins soon saw that matrix methods were the obvious ways of handling the resulting simultaneous equations so as to organize an efficient solution routine, a primary consideration when using desk calculators.

However, the approach led to more general consequences. Firstly, it led to an appreciation of the relationship, known as contragredience, which holds between, say, bending moments throughout the structure due to unit action at the release and movement at the release due to bending deformation throughout the structure. He had perceived a similar relationship in his book on cylindrical shells; for example when discussing the transformation of the stiffness matrix he remarked 'When matrices are used we obtain the symmetric form as a geometrical consequence, without appeal to the concept of work, which is merely the name of a scalar invariant associated with contragredient sets'. Secondly, it led to an understanding of the fact, stated in what became known as 'Jenkin's Lemma', that, in the analysis, the external loading could be applied to a reduced determinate structure different from that used to calculate the influence coefficients. This was analogous to the fact that in solving a differential equation (such as that for a cylindrical shell) the choice of particular integral is irrelevant: the complementary function will adjust itself to suit. These results, and the overall orderliness of the method, meant that the analysis could be extended to cover more general problems such as those involving three-dimensional structures, shear deformations, temperature or prestressing effects, slip at joints or lack of fit of members, or the calculation of deflections. The extension was almost automatic so that errors due to faulty

visualization were largely eliminated. Rigorous techniques for checking the numerical results were also made apparent.

When powerful computers became available the methods of flexibility analysis were largely replaced by those of stiffness (or deformation) analysis. This was natural because with the latter it was much easier to write a general program covering a large class of structures. The penalty of having to solve for an enormous number of unknowns was one that could be accepted especially since matrix algebra was now part of the general vocabulary of structural analysis. Probably this process has gone too far and many problems still arise for which flexibility analysis, with the additional insights provided by Ronald Jenkins, is the better tool. One example is a structure such as a portal frame or closed ring with up to three indeterminacies which can readily be solved manually, with members of varying stiffness adding little to the difficulties of computation. Another example is that in which there is a large number of structures to be analysed and these structures possess the same topology or connectivity but differing geometric or member properties. It could then be worthwhile to write a computer program specifically to solve that class of structure by influence coefficient methods; the application to certain optimization problems is evident.

Examples of the practical application of the cylindrical shell and influence coefficient theories may be seen in the following papers of which Ronald Jenkins was co-author:

The design of a reinforced concrete factory at Brynmawr, South Wales, 1953 (with O. N. Arup).

Design and construction of the Bank of England Printing Works at Debden, 1956 (with Sir Howard Robertson, O. N. Arup and H. F. Rosevear).

Complete cylindrical shell roofs precast on the ground (Abingdon Hangars), 1960 (with B. H. Broadbent).

The evolution and the design of the concourse at the Sydney Opera House, 1968 (with O. N. Arup).

A theoretical paper that is worth recalling here is his 'A variational method for design of cylindrical shells' presented at the Symposium on Concrete Shell Roof Construction in Oslo in 1956. Although it lay outside the main development of his thinking and he was, perhaps as a consequence, never really satisfied with it, the paper is not without practical interest. It gave a method of solving the then intractable problems of continuous or cantilevered cylindrical shells. The basic idea was to assume that the longitudinal stress distribution was the sum of various types of distribution such as linear or parabolic with depth. For each distribution type the remaining stresses were statically determinate so that the required proportion of each type could be chosen by variational methods so as to minimize the total strain energy in the structure.

John Blanchard

## Matrix analysis applied to statically indeterminate structures

### Introduction

When an engineer has decided he will design a statically indeterminate structure on the basis of Hooke's law and small displacements, that is, by accepting the premises of the linear theory, he is then faced with the question of by what method he will proceed. If he is under the impression that the simultaneous equations, arrived at by using what is known as the Classical Theory, will have to be solved by evaluating determinants (Cramer's rule) he will decide that that must be avoided at all costs. This has been the principal reason for the development of other methods based on the same premises, broadly classified as Distribution Methods, which adopt arithmetical means of solving the equations inherent in structural analysis without stating them as such.

It is now widely known that matrices serve to specify a sequence of arithmetical operations which will solve simultaneous equations quickly and without evaluating determinants. While it is true, therefore, that one method or the other, or perhaps a mixture of both, lends itself best to a particular problem, the Classical Theory has returned to practical usefulness.

Matrix algebra, however, is much more closely connected with linear theory than for the mere matter of solving simultaneous equations. It provides a compact and eminently suitable notation with consequences of two kinds. On the one hand it makes advances possible where the ordinary scalar notation appeared to have reached the limits of its development, and on the other, its very pattern carries

forward the reasoning more directly and fundamentally from the beginning.

It is with this latter restatement aspect that this paper is mainly concerned. For that purpose the self-contained field of the Classical Theory of skeletal structural systems has been chosen, and a step by step exposition is given of how the matter fits into matrix form. No attempt has been made to give a self-contained treatise on elementary matrix algebra, because many readable text-books are available. The compact volume by Aitken<sup>1</sup> can be recommended, from which the following quotation is taken:

'The theory of matrices . . . originates in the necessity of solving simultaneous linear equations and of dealing in a compact notation with *linear transformations* from one set of variables to a second set'.

In structural frame linear analysis, the matrix of coefficients of the simultaneous equations is positive-definite and symmetric, and the transformations are concerned with two kinds of variables which stand to each other in the relation of contragredient sets. In the paper, these useful and fundamental properties will be explained, followed by the theoretical argument, and concluding with a worked example of a simple nature which sets out in detail a sequence that may be applied to the solution of highly complicated statically indeterminate structures.

### Linear transformations of forces

The underlying ideas in structural analysis; linear transformations of forces and of small displacements, exhibit a general property which may be established without reference to frames.

Let  $x_1$  be a force applied to a rigid body at a given point and direction. It may be resolved into an equivalent set of forces and couples acting in any rectangular cartesian axes. This cartesian set, shown diagrammatically in Fig. 1, comprises two kinds of actions: three forces ( $X_1, X_2, X_3$ ) along the axes and three couples ( $X_4, X_5, X_6$ ) about the axes.

The geometrical detail of this resolution is an elementary matter.

Let  $(a, b, c)$  be the co-ordinates of the point, and  $(l, m, n)$  the direc-

tion cosines of the line of action of  $x_1$ , with respect to the axes ( $X_1 X_2 X_3$ ).

The resolution may conveniently be effected in two stages. Resolving  $x_1$  in directions parallel to the axes

$$\begin{aligned} X_1 &= lx_1 \\ X_2 &= mx_1 \\ X_3 &= nx_1 \end{aligned} \quad (1)$$

leads directly to the couples

$$\begin{aligned} X_4 &= (cm-bn)x_1 \\ X_5 &= (an-cl)x_1 \\ X_6 &= (bl-am)x_1 \end{aligned} \quad (2)$$

The resolutes  $X_1 X_2 \dots X_6$  are called the components of a vector denoted by  $X \equiv \{X_1 X_2 \dots X_m\}$ , the order  $m$  depending here on whether the case is two- or three-dimensional.

Although of no immediate concern, this paper adopts the convention that  $\{ \}$  brackets denote a *column* vector written in a row to save space, a *row* vector always having the *transpose* symbol attached, e.g.  $X' \equiv [X_1 \dots X_m]$  with the standard matrix brackets.

Let  $x_2$  be a couple applied to the rigid body about an axis whose direction cosines are  $(p, q, r)$ . Its resolution into the cartesian set is:

$$\begin{aligned} X_1 &= 0 \\ X_2 &= 0 \\ X_3 &= 0 \\ X_4 &= px_2 \\ X_5 &= qx_2 \\ X_6 &= rx_2 \end{aligned} \quad (3)$$

Any arbitrary number,  $n$ , of such direct forces and couples (both kinds are conveniently included in the term force), may be applied to the rigid body and may be considered to form a vector set denoted by:

$$x \equiv \{x_1 x_2 x_3 \dots x_n\}$$

The expression of the complete resolution of the  $x$  set into the  $X$  axes takes the form:

$$\begin{aligned} X_1 &= a_{11}x_1 + a_{12}x_2 \dots + a_{1j}x_j \dots + a_{1n}x_n \\ X_2 &= a_{21}x_1 + a_{22}x_2 \dots + a_{2j}x_j \dots + a_{2n}x_n \\ X_j &= a_{j1}x_1 + a_{j2}x_2 \dots + a_{jj}x_j \dots + a_{jn}x_n \\ X_m &= a_{m1}x_1 + a_{m2}x_2 \dots + a_{mj}x_j \dots + a_{mn}x_n \end{aligned} \quad (4)$$

A typical coefficient  $a_{ij}$  is of the type depending only on spatial relations already given in detail and may be defined as the value of  $X_j$  when  $x_j=1$  and all the other components of  $x$  are zero. This way of defining a coefficient is so useful that it is worth mentioning this meaning is conveyed by the partial differential coefficient:

$$\frac{\partial X_j}{\partial x_i} = a_{ij} \quad (5)$$

The set of Equation 4 is a linear transformation of forces. One way of expressing it briefly is by means of a typical row:

$$X_i = \sum_j a_{ij} x_j \quad (6)$$

The basic idea of matrices is the separation of the different kinds of entities into compartments in accordance with certain algebraic rules. The full matrix expression for Equation 4 is written:

$$\begin{bmatrix} X_1 \\ X_2 \\ \vdots \\ X_i \\ \vdots \\ X_m \end{bmatrix} = \begin{bmatrix} a_{11} & a_{12} & a_{13} & \dots & a_{1j} & \dots & a_{1n} \\ a_{21} & a_{22} & a_{23} & \dots & a_{2j} & \dots & a_{2n} \\ \vdots & \vdots & \vdots & \dots & \vdots & \dots & \vdots \\ a_{i1} & a_{i2} & a_{i3} & \dots & a_{ij} & \dots & a_{in} \\ \vdots & \vdots & \vdots & \dots & \vdots & \dots & \vdots \\ a_{m1} & a_{m2} & a_{m3} & \dots & a_{mj} & \dots & a_{mn} \end{bmatrix} \begin{bmatrix} x_1 \\ x_2 \\ \vdots \\ x_j \\ \vdots \\ x_n \end{bmatrix} \quad (7)$$

The *rectangular* array of coefficients arranged in  $m$  rows and  $n$  columns is denoted by the symbol  $A$ . The vector  $X$  is a matrix of  $m$  rows and one column, and the vector  $x$  of  $n$  rows and one column.

Thus another brief way of expressing the linear transformation in question is provided in matrix notation by:

$$X = Ax \quad (8)$$

The rule for *pre-multiplying* a vector  $x$  by a matrix  $A$  is here self-evident. Any component  $X_i$  is the *inner product* of the elements of the  $i$ th row of  $A$  with the elements of the *column* vector  $x$ . This means just the same as Equation 6.

Therefore the double suffix notation not only indicates the components of the vector to which the coefficients are attached but also specifies their position in the matrix array.  $a_{ij}$  is the element in the  $i$ th row and  $j$ th column often put  $A = [a_{ij}]$ .

It is obvious enough that when  $x$  is any arbitrary group the natural order of expression for its resolutes is  $X = Ax$  where, in general, a reversed force transformation has no meaning.

To make a small digression to demonstrate the power of matrices, the text books explain the meaning of the reciprocal of a matrix (neces-

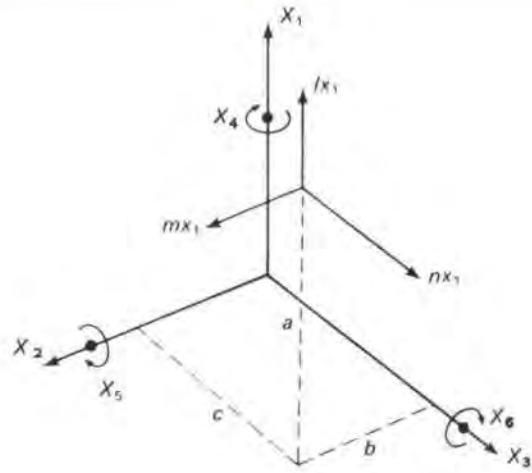

**Fig. 1**  
Resolution of forces

sarily *square*; that is, of the same number of rows and columns) and show that  $A^{-1}A = I$ , the latter symbol denoting the *unit* matrix. The reciprocal is often easily found in transformations.

Suppose  $x$ , instead of being an arbitrary group of scattered forces, represents another set in cartesian axes. In this case  $x$  has the order of  $m \times 1$  and  $A$  is a square matrix of order  $m \times m$ . The reverse transformation is obtained by pre-multiplying Equation 8 by  $A^{-1}$ :

$$\begin{aligned} A^{-1}X &= A^{-1}Ax = Ix = x \\ \text{i.e. } x &= A^{-1}X \end{aligned}$$

Suppose further that a transformation  $X = Ax$  is required between two sets of oblique axes. The trigonometrical nightmare of working this out directly becomes a simple routine by setting up any convenient rectangular axes,  $Y$ . The transformations  $Y = Bx$  and  $Y = CX$  may be easily set out as already shown, whence

$$\begin{aligned} X &= C^{-1}Y = C^{-1}Bx \\ \therefore A &= C^{-1}B \end{aligned}$$

### Linear transformations of small displacements

The postulated rigid body, diagrammatically represented in Fig. 2 with its attached set of cartesian axes, now comes in useful.

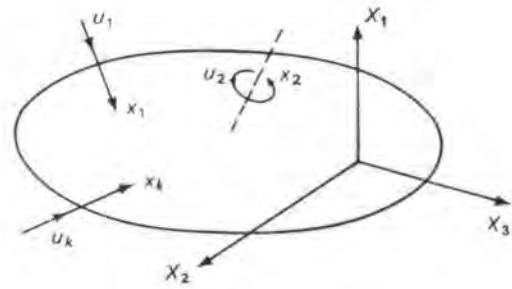

**Fig. 2**  
Rigid body components of applied forces and displacements

The first thing to appreciate about a displacement transformation is that its natural order of expression is the other way round to a force transformation. A small movement given to the rigid body may be described in terms of the displacements of the cartesian axes, comprising two kinds: three translations ( $U_1 U_2 U_3$ ) and three rotations ( $U_4 U_5 U_6$ ) in the respective directions of ( $X_1 X_2 \dots X_6$ ) and all denoted by the vector:

$$U \equiv \{U_1 U_2 U_3 \dots U_m\}$$

Since the body may be given any kind of movement, this  $U$  set is arbitrary; but not so the  $x$  set corresponding with the  $x$  directions, because these are related by the condition that the body moves as a whole.

Before dealing with the geometry of this kind of transformation it is necessary to define what is meant by a displacement. The displacement component  $u_1$  is defined as the amount of movement at the position, and projected *in the direction* of  $x_1$ . Another way of looking at it is to see that if a constant force  $x_1$  is applied while the movement of the body takes place the work done in this respect is  $u_1 x_1$ .

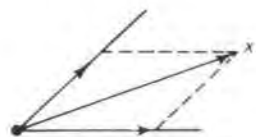

**Fig. 3**  
Resolutes of a force  
in plane oblique axes

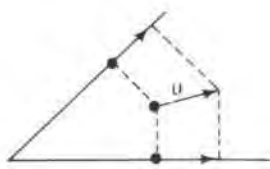

**Fig. 4**  
Resolutes of a displacement  
in plane oblique axes

It is important to notice the different kinds of resolution for forces and displacements because they explain much. They are shown diagrammatically for a two-dimensional case in Figs. 3 and 4.

For the present, a small displacement means that any associated angular movement is small enough for the angle in radians to be equal to the sine of the angle.

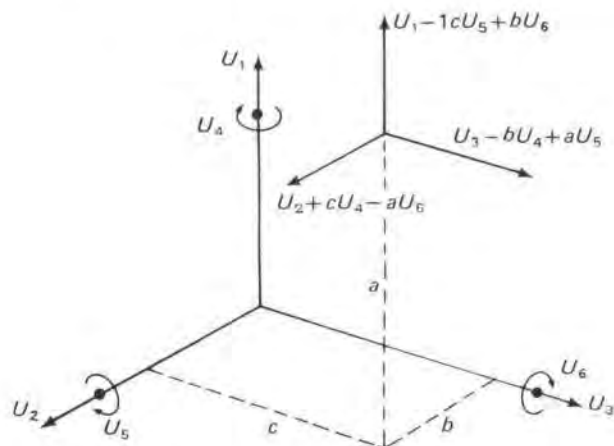

**Fig. 5**  
Transformation of a displacement

The transformation of small displacements corresponding to Fig. 1 is shown in Fig. 5. Again it may be carried out in two stages; firstly to a set of directions at  $x_1$  parallel to the cartesian axes, from which it is evident that the component of translation in the direction of  $x_1$  is:

$$u_1 = l(U_1 - cU_5 + bU_6) + m(U_2 + cU_4 - aU_6) + n(U_3 - bU_4 + aU_5) \quad (10)$$

$$= lU_1 + mU_2 + nU_3 + (cm - bn)U_4 + (an - cl)U_5 + (bl - am)U_6$$

Similarly, the rotation component  $u_2$  in the direction of the corresponding applied couple  $x_1$  is:

$$u_2 = pU_4 + qU_5 + rU_6 \quad (11)$$

In Equations 10 and 11 exactly the same coefficients as before have appeared but in transposed order. It follows that when  $u \equiv \{u_1, u_2, \dots, u_n\}$  are small displacements in the respective directions of  $x \equiv \{x_1, x_2, \dots, x_n\}$  that the corresponding displacement transformation becomes:

$$u = A'U \quad \text{where } A' \equiv [a_{ij}] \text{ when } A \equiv [a_{ji}] \quad (12)$$

Again, in the general case, a reversed transformation has no meaning. Corresponding with Equation 5 another meaning for the coefficients has thus appeared:

$$\frac{\partial u_j}{\partial U_i} = a_{ij} \quad (13)$$

By comparing Equations 8 and 12 the property of the relation between force and small displacement transformations is revealed. This appearance of a transformation matrix and its transpose and these opposite orders in expression are what is implied in saying that  $X$  and  $U$  or  $x$  and  $u$  are *contragredient* sets.

No connection between forces and displacements has been implied. A permissible statement from these results is, for example, that resolution of forces is more readily visualized than displacements and the setting up of a force transformation is therefore a convenient way of finding the  $u$  set from a given  $U$  set.

Without departing from the meaningful orders a demonstration that contragredience holds also for oblique axes may be given by showing that the work done by a set of constant forces when the rigid body undergoes a small displacement is a scalar invariant, that is, independent of the axes of reference:

From  $X = Ax$  and  $u = A'U$  i.e.  $u' = U'A$  and granting that matrix algebra is *associative*, the invariance is immediately established:  $w = U'X = U'(Ax) = (U'A)x = u'x$ .

## Transformations applied to structural frames

This section is concerned with showing – what at first may seem rather surprising – that the type of linear transformations already discussed are apposite and similarly related in the case of frames.

Let  $\bar{x}$  denote the set of internal forces and couples (stress resultants) at a given current point on the longitudinal axis of a member. In a plane frame the components of  $\bar{x} \equiv \{\bar{x}_1, \bar{x}_2, \bar{x}_3\}$  are a direct force, shear force and bending moment. In a three-dimensional frame  $\bar{x} \equiv \{\bar{x}_1, \dots, \bar{x}_6\}$  are a direct force, two shear forces, two bending moments and a twisting moment. The components may be taken in any consistent order.

Here again the symbol  $\bar{x}$  is given a double duty by being understood also to indicate the position of the current point in question, and the components a set of directions.

Corresponding with the directions of the components of  $\bar{x}$ , what is the nature of displacements denoted by  $\bar{u} \equiv \{u_1, u_2, \dots\}$ ?

In the first instance each component of  $\bar{u}$  may be regarded as a relative movement between each side of an abrupt release of the restraint required to maintain the corresponding type of continuity in the member at that cross-section. Mechanical diagrams of sliding joints, hinges, etc. may be employed to interpret the imagined displacements covered by this definition. However, it is made clear by Fig. 6 which shows some relative displacements and their respective stress-resultants. For example, a change in direction is the displacement corresponding to a bending moment.

These relative displacements have been defined in respect of directions in accordance with the earlier general statement of what is meant by a displacement. A very simple example now suffices to show that  $\bar{x}$  and  $\bar{u}$  are contragredient vectors and possess the general property in their relation to any set of forces,  $X$ , applied to the frame, and their corresponding displacements,  $U$ .

Fig. 7 shows a bent cantilever. The bending moment at the selected current point  $\bar{x}$  due to an  $X$  set of forces (not necessarily all applied at one point at the end, as shown) is:

$$\bar{x}_1 = X_1 + aX_2 + bX_3$$

Fig. 8 shows the displacements in the  $X$  directions produced by a corresponding small angular movement,  $\bar{u}_1$ . They are

$$U_1 = \bar{u}_1$$

$$U_2 = a\bar{u}_1$$

$$U_3 = b\bar{u}_1$$

The transposed relations and opposite orders of expression are again apparent and, in general, if  $\bar{x} = AX$  then  $U = A'\bar{u}$ , where  $A$  denotes the matrix of the transformation.

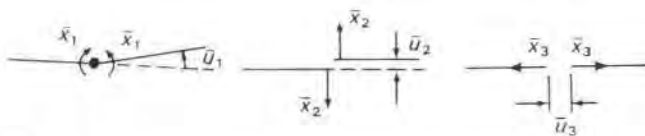

**Fig. 6**  
Some typical discontinuities and associated stress resultants

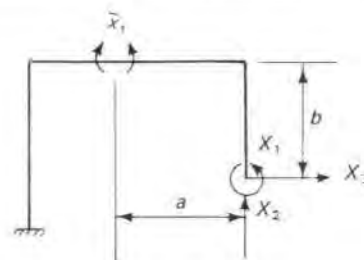

**Fig. 7**  
A stress couple due to applied forces

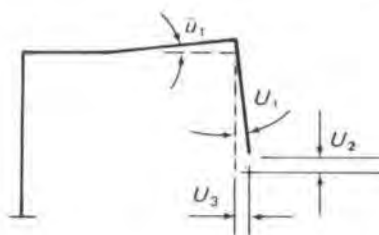

**Fig. 8**  
Displacements due to corresponding rotation

An amplification of this example shows again how a matrix relation is a multiplicity built up from a particular. If at  $\bar{x}$  the other two types of discontinuity, shown in Fig. 6, are included it can be seen at once that

$$\begin{bmatrix} \bar{x}_1 \\ \bar{x}_2 \\ \bar{x}_3 \end{bmatrix} = \begin{bmatrix} 1 & a & b \\ \cdot & 1 & \cdot \\ \cdot & \cdot & 1 \end{bmatrix} \begin{bmatrix} X_1 \\ X_2 \\ X_3 \end{bmatrix}$$

and

$$\begin{bmatrix} U_1 \\ U_2 \\ U_3 \end{bmatrix} = \begin{bmatrix} 1 & \cdot & \cdot \\ a & 1 & \cdot \\ b & \cdot & 1 \end{bmatrix} \begin{bmatrix} \bar{u}_1 \\ \bar{u}_2 \\ \bar{u}_3 \end{bmatrix}$$

Had the selected current point been in one of the vertical legs of the cantilever the above transformation would change in arrangement because  $\bar{x}_2$  would still represent a shear stress resultant, etc. In fact,  $A$  is a functional matrix in regard to all current points. It is most conveniently expressed in the form, known long before matrices were applied to structural analysis, of sketch diagrams over the whole structure for each stress resultant component in respect of each applied force. This is very easily visualized from the previously mentioned definition of a transformation coefficient:

$$\frac{\partial \bar{x}_i}{\partial X_j} = a_{ij}$$

that is, the value of  $\bar{x}_i$  when  $X_j=1$  and all the other components of  $X$  are zero.

Fig. 9 shows the sketch for coefficient  $a_{13}$ , bending moments in the cantilever, in respect of  $X_3=1$ , in this example.

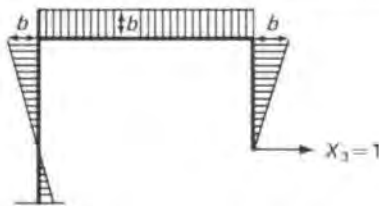

Fig. 9  
Bending moments when  $X_3=1$

Now, in a deformed continuous structure there are present at a current point relative displacements of the same nature as  $\bar{u}$  due to strains in the form of deformations. The deformations corresponding with the directions of the  $\bar{x}$  components in a short axial length of a member will be denoted by:

$$d\bar{u} \equiv \{du_1, du_2, \dots\}$$

Some typical distortions and their respective stress resultants are shown in Fig. 10.

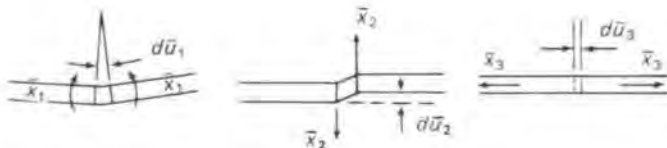

Fig. 10  
Some typical distortions of a short length

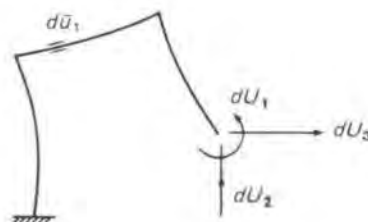

Fig. 11  
Deformed frame

Fig. 11 shows the same bent cantilever in a deformed state.  $dU$  means the part of the displacements in the  $X$  directions due only to  $d\bar{u}$  in a short axial length at the particular current point. So by the same geometrical considerations:

when  $\bar{x} = AX$  (14)

then  $dU = A'd\bar{u}$  (15)

Thus if  $d\bar{u}$  were known for every short length into which the axial lines are divided, the total displacements in the  $X$  directions could be obtained by summation over the whole structure:

$$U = \int dU = \int A'd\bar{u} \quad (16)$$

This integration notation is explained by putting the expression into extended form:

If  $A \equiv [a_{ij}]$ , i.e.  $A' \equiv [a'_{ij}]$

$$U_1 = \int dU_1 = \int a'_{11}d\bar{u}_1 + \int a'_{12}d\bar{u}_2 + \dots$$

$$U_2 = \int dU_2 = \int a'_{21}d\bar{u}_1 + \int a'_{22}d\bar{u}_2 + \dots$$

$$U_3 = \int dU_3 = \int a'_{31}d\bar{u}_1 + \int a'_{32}d\bar{u}_2 + \dots$$

$$\text{i.e. } U_i = \sum_j a'_{ij}d\bar{u}_j \quad (17)$$

This section has demonstrated some geometrical properties of statically determinate frames. Other examples of this kind should be examined to familiarize the ideas. That these are also properties of statically indeterminate structures will be shown later.

It is well-known that a statically determinate structure can adapt itself to temperature changes without stress resultants arising from this cause. The extensional and flexural distortions per unit length of the members can be calculated from the average temperature change and temperature gradient, respectively, over the cross-section. The foregoing shows that temperature deflections of the structure at any required set of points and directions may be found by integrating (or summing by Simpson's rule) these distortions with the relevant stress resultant coefficient diagrams obtained by applying unit forces in the given set, one at a time.

### Displacements due to stresses

Relations between distortions,  $d\bar{u}$ , and stress resultants,  $\bar{x}$ , must be established in order to calculate a displacement due to loads applied to a structure. These relations are independent of the transformations shown to be linear when deformations are small enough to make no appreciable change in the frame layout, as far as statics are concerned.

Linear transformations supply one necessary condition for the principle of superposition, already evidenced in deriving a displacement as the sum of products obtained by pairing off a set of geometrical coefficients with a set of distortions. For the principle to extend to analysis, the other necessary condition is a linear relation between distortions and stress resultants, i.e. the structural materials must be assumed to behave in accordance with Hooke's Law. Within this elastic range, which is assumed with various degrees of approximation to be the working stress range, it is customary to quote results of the theory of elasticity to supply the required relations. The fundamental elastic constants are Young's modulus,  $E$ , and Poisson's ratio,  $\sigma$ . With the exception of temperature effects, forced displacements and the like, only relative values of the moduli of the materials employed need be known for analytical purposes. On the other hand, the theory of elasticity may be avoided altogether by establishing distortion-stress resultant relations from appropriate tests on sample members of the frame.

This last point is significant, although somewhat unpractical, and has often been mentioned, and it provides a good reason for beginning with a matrix expression for the distortion-stress resultant relation at a current point:

$$d\bar{u} = \bar{G}\bar{x}ds \quad (18)$$

where the scalar,  $ds$ , denotes the length of a short axial length of the member at the current point.

$\bar{G}$  may be termed a flexibility matrix and has important and useful properties. A component  $\bar{g}_{ij}$  is the distortion of a unit length in direction  $i$  due to  $\bar{x}_j=1$ , and may either be found from tests of the kind mentioned above, or else expressed in terms of the elastic constants and the geometrical properties of the cross-section.

Without going further into this and other matters (such as members bent to a relatively small radius) falling within the province of the theory of elasticity, some of the components of  $\bar{G}$  will be quoted in their familiar form.

Stresses acting over the cross-section of a member are of two kinds: (a) Direct stresses, whose corresponding strains give rise to extensional and flexural distortions. The simple theory of bending, derived from Navier's hypothesis, is applicable in a member of small lateral dimensions compared with its length. This assumption of straight line stress distribution over a cross-section is linearity again and the transformations connecting stress and stress resultant, and strain and distortion, are precisely of the kind already demonstrated. The consequent parallel between direct stress distribution and frame analysis is shown at the end of this section; although for the main thesis it is sufficient to know that when the axes of reference are the centroid and the principal axes of the cross-section, the distortion-stress resultant relations are an isolated set, that is, a set of one-to-one in the familiar form:

direct:  $d\bar{u}_1 = \frac{1}{EA}\bar{x}_1ds$  i.e.  $\bar{g}_{11} = \frac{1}{EA}$  (19)

bending:  $d\bar{u}_2 = \frac{1}{EI}\bar{x}_2ds$  i.e.  $\bar{g}_{22} = \frac{1}{EI}$

where the subscript numbering may be in any consistent order.  $A$  denotes the area of the cross-section and  $I$  its moment of inertia about the relevant principal axis.

(b) Shear stresses, associated with the transverse and torsional distortions. Transverse distortions are negligible in frame analysis and are usually omitted. There is no simple theory for torsional distortions, except for *thin* sections and circular sections. The latter is the only case where the polar moment of inertia is the appropriate geometrical property for the flexibility coefficient; for other shapes the coefficient has to be obtained from first principles or from published tables. In an unsymmetrical section, an isolated set of relations for this group has a different centre than that for direct stresses.

However, it is convenient and sufficient for the present purpose to assume a cross-section with two axes of symmetry, for which the isolated set of elastic relations becomes the extended form of Equation 18

$$\begin{bmatrix} d\bar{u}_1 \\ d\bar{u}_2 \\ d\bar{u}_3 \\ \vdots \\ \vdots \\ \vdots \end{bmatrix} = \begin{bmatrix} \bar{g}_{11} & & & \\ & \bar{g}_{22} & & \\ & & \bar{g}_{33} & \\ & & & \ddots \\ & & & & \ddots \\ & & & & & \ddots \end{bmatrix} \begin{bmatrix} \bar{x}_1 \\ \bar{x}_2 \\ \bar{x}_3 \\ \vdots \\ \vdots \\ \vdots \end{bmatrix} ds \quad (20)$$

where the non-zero elements of  $\bar{G}$  are in the leading diagonal only, and of the type given in Equation 19.

This matrix, the  $\bar{G}$  of Equation 20, is basic in linear analysis. It has two important properties:

Being a diagonal matrix, it is obviously *symmetric*. In general the latter term means that  $\bar{G}^T = \bar{G}$ , i.e. the non-diagonal elements are reflected about the leading diagonal.

All the elements in its leading diagonal are positive for the physical reason that a distortion will be in the direction of the corresponding stress resultant and not opposite to it.  $\bar{G}$  is therefore *positive definite*, which in general means that all principal minors are positive.

It will soon be shown that the type of transformations associated with a symmetric matrix is:

$$\bar{E} = H^T \bar{G} H \quad (21)$$

where  $\bar{E}$  could be the distortion-stress resultant relation in some other axes.

By the algebraic rule for transposing a matrix product it can be seen that  $\bar{E}^T = \bar{E}$  (still symmetric). It is proved in text books that the *rank* of a matrix is unchanged by transformation, i.e. if  $\bar{G}$  is positive definite, so is  $\bar{E}$ .

The positive definite property requires some amplification. As already mentioned, transverse distortions are usually inappreciable in frame analysis. This is often the case, also, for extensional distortions. A neglected distortion means no flexibility in that respect, and nullifies the corresponding diagonal element of  $\bar{G}$ . However, such relations may be omitted altogether from the analysis, and the matrix contracted accordingly. In many examples of plane frame analysis, only the bending relation remains, and then  $\bar{G}$  contains one element

( $\bar{g}_{11} = \frac{1}{EI}$ ) which therefore becomes a scalar quantity.

Contraction may also exclude an infinite flexibility, i.e. a distortion which the member has comparatively no strength to resist.

These qualifications are summarized by saying that significant distortions are those which contribute to strain energy. The best way of grasping the point is to put zero or infinity for some of the flexibility coefficients in an example. This paper therefore continues with the understanding that  $\bar{G}$  has an inverse  $\bar{G}^{-1}$  and both are positive definite.

Let  $\bar{x}^o$  denote the set of stress resultants present at a current point owing to any given system of loads applied to a statically determinate structure.

The load system is not necessarily the same as  $X$  which denotes a hypothetical set of forces applied at the positions and in the directions in which displacements are to be calculated.

$\bar{x} = AX$  is a transformation giving stress resultants due to the hypothetical set, and as already explained, it may be conveniently expressed in the form of sketch diagrams over the whole structure for each kind of stress resultant in respect of each unit component of  $X$ .

The corollary of this transformation was given in Equation 16:

$$U = \int dU = \int A^T d\bar{u}$$

where  $U$  is a set of displacements in the  $X$  directions.

When the distortions, denoted by  $d\bar{u}^o$ , are those arising from the given load system, the required displacements are obtained by substituting the distortion-stress resultant relation of Equation 18:

$$d\bar{u}^o = \bar{G} \bar{x}^o ds$$

Then

$$U^o = \int A^T \bar{G} \bar{x}^o ds \quad (22)$$

The individual integrations are of the kind shown in Equation 17 but now, in general, they are integrals of products of three variables.

It makes for neatness in expressing the components of  $U$  to adopt the *summation* convention, by which is understood the sum for all combinations of repeated subscripts not specified on the left-hand side of the equation. With this convention the  $\mathcal{E}$  is omitted from the general expression for Equation 17, which becomes:

$$U_i = \int a_{ij} d\bar{u}_j$$

Likewise, the general expression for a component of  $U^o$  in Equation 22, noting it begins with the transpose of  $A$ , is

$$U_i^o = \int a_{ij} \bar{g}_{jk} \bar{x}_k^o ds \quad (23)$$

When  $\bar{G}$  is the diagonal matrix of Equation 20, a large reduction in the number of terms is obtained because non-diagonal elements of  $\bar{G}$  are absent, and

$$U_i^o = \int a_{ij} \bar{g}_{ij} \bar{x}_i^o ds \quad (24)$$

A still further reduction is obtained when  $\bar{G}$  consists of the single element  $\bar{g}_{11}$ , giving

$$U_i^o = \int a_{i1} \bar{g}_{11} \bar{x}_1^o ds \quad (25)$$

The last case provides an opportunity of relating the hitherto general notation with that to which engineers are more accustomed.

In a plane frame, where flexure is the only significant distortion,

$\bar{g}_{11} = \frac{1}{EI}$  and  $M^o$  denotes bending moments due to loads. All that is

required of  $A$  is the row  $a' \equiv [M_1 \ M_2 \ M_3]$  in respect of bending due to an  $X$  set. These components are the moments when the  $X$  set takes the values in the following table:

|            | $X_1$ | $X_2$ | $X_3$ |   |   |   |
|------------|-------|-------|-------|---|---|---|
| $M_1$ when | 1     | 0     | 0     | . | . | . |
| $M_2$ ..   | 0     | 1     | 0     | . | . | . |
| $M_3$ ..   | 0     | 0     | 1     | . | . | . |
| .          | .     | .     | .     | . | . | . |

Then, there are the alternative expressions for Equations 22 and 25:

$$U^o = \int a' \frac{M^o}{EI} ds \quad (26)$$

and

$$U_i^o = \int \frac{M_i M^o}{EI} ds \quad (27)$$

or in full

$$U_1^o = \int \frac{M_1 M^o}{EI} ds \quad U_2^o = \int \frac{M_2 M^o}{EI} ds \quad U_3^o = \int \frac{M_3 M^o}{EI} ds$$

To carry out the integrations of Equations 22 to 27 on the lines indicated, two more sets of sketch diagrams will be required: a set for each kind of stress resultant  $\bar{x}^o$  and a set for each element of the flexibility matrix,  $\bar{G}$ . All this will be illustrated in the worked example and, for the present, sufficient explanation of what is meant can be given by a simple extension to the example of Fig. 7.

Fig. 12 shows a point load applied to the bent cantilever and sketches the bending moments arising therefrom. Each member is assumed to have a constant moment of inertia, as indicated.

The deflection in direction  $X_3$  due to application of the point load  $P$ , is obtained by integrating the diagrams of Fig. 9 with those of Fig. 12. Only that part of the structure subjected to bending by  $P$  comes into the integration and the constant flexibility coefficients come outside the integral sign.

This consideration of frames in which stress resultants are determined from statics alone, completes the foundation of the method of analysis of statically indeterminate structures introduced in the next section of the paper.

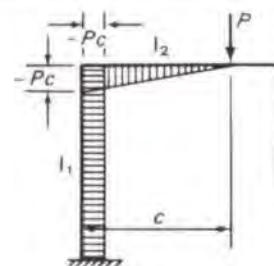
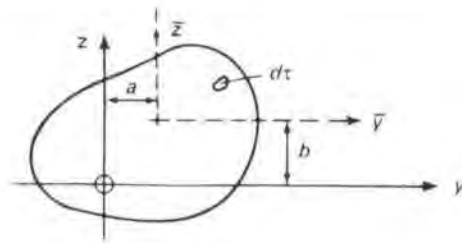

Fig. 12  
Bending moments in respect of load  $P$

The side issue of the distribution of *direct* stress over a cross-section of a member provides another matrix application of the same class as that of frame analysis. For this immediate purpose it is convenient to make some of the notations different from those adopted elsewhere in the paper.





**Fig. 13**  
Unsymmetrical cross-section

Fig. 13 shows an unsymmetrical cross-section in the plane of which these are two arbitrary rectilinear axes,  $y$  and  $z$ . The third axis is the longitudinal,  $s$ , through the origin,  $o$ .

According to Navier's hypothesis, cross-sections remain plane after distortion so that when the member is initially straight in the region under consideration, the strain at point  $(y, z)$  is

$$\begin{aligned} \frac{\partial u}{\partial s} &= U_o - zU_y - yU_z \\ &= [1 \ -z \ -y] \begin{bmatrix} U_o \\ U_y \\ U_z \end{bmatrix} = A'U \end{aligned}$$

The components of  $U$  may be expressed in terms of the displacements at the point;  $(u, v, w)$  in the respective directions of  $(s, y, z)$ :

Strain at origin:  $U_o = \frac{\partial u_o}{\partial s}$

Change in curvature about  $y$  axis:  $U_y = \frac{\partial^2 w}{\partial s^2}$

Change in curvature about  $z$  axis:  $U_z = \frac{\partial^2 v}{\partial s^2}$

Let stress resultants be denoted by:  $X = \{P \ M_y \ M_z\}$

where  $P$  denotes direct force.

$M_y$  .. bending moment about  $y$  axis

$M_z$  .. bending moment about  $z$  axis.

The elements of the stress resultants are the force in a small area,  $dA$ , and its couples about the axes:

$$dX \equiv \begin{bmatrix} dP \\ dM_y \\ dM_z \end{bmatrix} = \begin{bmatrix} p \\ -zp \\ -yp \end{bmatrix} dA = \begin{bmatrix} 1 \\ -z \\ -y \end{bmatrix} p dA = A p dA$$

where  $p$  denotes the direct stress at point  $(y, z)$ .

Thus, strain and stress elements are contragredient sets.

The elastic relation is provided by

$$E = \frac{\text{stress}}{\text{strain}} \quad \text{i.e. } p = E \frac{\partial u}{\partial s}$$

and leads to the distortion-stress resultant relation by the surface integral over the region of the cross-section:

$$X = \int A p dA = E \int A \frac{\partial u}{\partial s} dA = E \int A A' dA U = G^{-1} U$$

Thus the rigidity matrix  $G^{-1} = E \int A A' dA$  is clearly symmetrical,  $A A'$  is here the outer product of the same vectors, and *in extenso*:

$$G^{-1} = E \begin{bmatrix} \int dA & -\int z dA & -\int y dA \\ -\int z dA & \int z^2 dA & \int y z dA \\ -\int y dA & \int y z dA & \int y^2 dA \end{bmatrix}$$

If the point  $(y, z) = (a, b)$  is the origin of a new pair of axes,  $\bar{y}$  and  $\bar{z}$  parallel to  $y$  and  $z$ , the rigidity in these new axes,  $\bar{G}^{-1}$ , may be obtained by a transformation.

The new strain components are

$$\begin{aligned} \bar{U}_o &= U_o - bU_y - aU_z \\ \bar{U}_y &= U_y \\ \bar{U}_z &= U_z \end{aligned}$$

$$\text{i.e. } U \equiv \begin{bmatrix} U_o \\ U_y \\ U_z \end{bmatrix} = \begin{bmatrix} 1 & b & a \\ . & 1 & . \\ . & . & 1 \end{bmatrix} \begin{bmatrix} \bar{U}_o \\ \bar{U}_y \\ \bar{U}_z \end{bmatrix} = H_1' \bar{U}$$

Similarly the new stress resultants are:

$$\begin{aligned} \bar{P} &= P \\ \bar{M}_y &= M_y + bP \\ \bar{M}_z &= M_z + aP \end{aligned}$$

$$\text{i.e. } \bar{X} \equiv \begin{bmatrix} \bar{P} \\ \bar{M}_y \\ \bar{M}_z \end{bmatrix} = \begin{bmatrix} 1 & . & . \\ b & 1 & . \\ a & . & 1 \end{bmatrix} \begin{bmatrix} P \\ M_y \\ M_z \end{bmatrix} = H_1 X$$

Substituting in  $X = G^{-1} U$

$$\begin{aligned} \bar{X} &= H_1 X = H_1 G^{-1} U = H_1 G^{-1} H_1' \bar{U} \\ \text{i.e. } \bar{G}^{-1} &= H_1 G^{-1} H_1' \end{aligned}$$

If  $b = \int z dA / \int dA$  and  $a = \int y dA / \int dA$  this transformation isolates the first leading element in  $G^{-1}$ . In fact, the origin has been moved, in a roundabout way, to the centroid of the cross-section.

When this transformation is carried through

$$\begin{aligned} \bar{G}^{-1} &= E \begin{bmatrix} \int dA & -\int \bar{z} dA & -\int \bar{y} dA \\ -\int \bar{z} dA & \int \bar{z}^2 dA & \int \bar{z} \bar{y} dA \\ -\int \bar{y} dA & \int \bar{z} \bar{y} dA & \int \bar{y}^2 dA \end{bmatrix} \\ &= E \begin{bmatrix} \int dA & . & . \\ . & \int z^2 dA - b^2 \int dA & \int zy dA - ba \int dA \\ . & \int zy dA - ba \int dA & \int y^2 dA - a^2 \int dA \end{bmatrix} \end{aligned}$$

To complete the isolation of  $\bar{G}^{-1}$ , another 'fore and aft' transformation of the same kind could be applied to the unisolated block, e.g.

$$H_2 = \begin{bmatrix} 1 & . \\ a_{12} & 1 \end{bmatrix}$$

in which

$$a_{12} = -\int \bar{z} \bar{y} dA / \int \bar{z}^2 dA$$

The latter may be interpreted as arriving at a pair of conjugate axes; but because isolating transformations employed in structural analysis require no geometrical interpretation, neither this nor the question of an *orthogonal* transformation to arrive at the principal axes, will be pursued further.

It will be shown that a set of simultaneous equations may be reduced, by isolating transformations, to a set of one-to-one relations and that this is an intermediate stage in the solution. In this connection, however, geometrical interpretations have played a large part in the history of structural analysis. Ostenfeld<sup>2</sup> developed extremely elegant methods, by introducing imaginary stiff levers, etc., of reaching the maximum degree of partial isolation. Hardy Cross used the transformations (not explicitly stated as such) just discussed for his Column Analogy. Although this analogy comes to the same thing as Ostenfeld's approach and might be considered confusing rather than clarifying, it did enable Hardy Cross to enunciate an important theorem in the analysis of a bent (a single portal type frame). The application of matrices shows that this theorem is quite general to all kinds of structural frames (see next section).

### Analysis of statically indeterminate frames

This section and the next cover the thesis of the paper: the expression of the Classical theory and its application in the already defined general terms. There follows later an illustrative worked example.

Briefly, the initial structure in equilibrium is that obtained by postulating the introduction of a sufficient number of discontinuities to make a mechanically stable, statically determinate structure. The analysis derives, simply, from the statement of the condition that eliminates those discontinuities.

The imagined determinate structure will be called a *primary* system. The postulated discontinuities, the number ( $n$ ) of which is the degree of statical indeterminacy of the actual structure, have been discussed and typified in Fig. 6. For example, if the frame illustrated in Fig. 7 were in fact built-in at both ends, the figure shows a possible primary system obtained by a complete cut at the foot of one leg.

In this way the linear analysis of a statically indeterminate frame may be expressed by the following steps, in which it should be understood that the current point referred to in (a), (b), (c) and (d) is the same one in each case, but the relations expressed therein are independent of each other:

(a) Let  $\bar{x}^o$  denote the set of stress resultants at a current point in the primary system owing to the loads on the structure.

(b) Suppose that an arbitrary set,  $X \equiv \{X_1, X_2, \dots, X_n\}$ , of pairs of equal and opposite forces are applied to the primary system at each side, and in the direction, of each postulated discontinuity. The stress resultants,  $\bar{x}$ , arising at a current point from the applied set represent a linear transformation:

$$\bar{x} = AX \quad (28)$$

(c) By the property of contragredience, an arbitrary set of deformations,  $d\bar{u}$ , at the current point will produce in the  $X$  directions relative

displacements,  $dU \equiv \{dU_1, dU_2, \dots, dU_n\}$ , between each side of each postulated discontinuity and amounting to:

$$dU = A'd\bar{u} \quad (29)$$

(d) In a short axial length,  $ds$ , of the member at the current point, the distortion-stress relations are denoted by:

$$d\bar{u} = \bar{G}\bar{x}ds \quad (30)$$

(e) The total relative displacements in the  $X$  directions due to any distribution of distortions of the members are expressed by summation over the whole structure:

$$U = \int dU = \int A'd\bar{u} \quad (31)$$

Hence, by introducing Equation 30, the relative displacements due to any distribution of stress resultants are:

$$U = \int A'\bar{G}\bar{x}ds \quad (32)$$

(f) The relative displacements in the  $X$  directions may be divided into two parts:

(1) Due to the loads on the primary system:

$$U^o = \int A'\bar{G}\bar{x}^o ds \quad (33)$$

(2) Due to the application of an  $X$  set itself, as defined in (b):

$$U = \int A'\bar{G}\bar{x}ds = \int A'\bar{G}AdX = GX \quad (34)$$

$G = \int A'\bar{G}AdX$  gives the flexibility of the whole primary system in the  $X$  directions and depends only on its geometry and elastic properties.

(g) The values of  $X$  which eliminate the postulated discontinuities are called the redundants and are obtained from the condition that in the actual structure  $U^o + U = 0$ . The latter symbol denotes a null matrix (vector in this case) in which all components are zero.

$U^o$  is obtained from the integrations of Equation 33. By substituting Equation 34 in the given condition, the redundants appear as the unknowns in a set of  $n$  simultaneous equations:

$$U^o + GX = 0 \quad (35)$$

(h) Finally, when the redundant set,  $X$ , has been found the stress resultants at a current point are the sum of two parts:

$$\bar{x} = \bar{x}^o + AX \quad (36)$$

Both (a) and (b) describe equilibrium states conserved throughout the analysis.

It is evident in Equation 34 that since  $\bar{G}$  is symmetric positive definite at all current points, this property also holds for  $G$  — a property made use of in the method of solving a set of simultaneous equations denoted by Equation 35, given in the next section.

In matrix notation the solution is symbolized by pre-multiplying both terms of Equation 35 by  $G^{-1}$ :

$$X = -G^{-1}U^o \quad (37)$$

When several load systems have to be considered it sometimes pays to find this reciprocal matrix (aptly termed the *stiffness* of the primary system) instead of solving each case separately.

The method of drawing sketch diagrams required for the integrations has already been described. Manifestly from Equation 36, it is sometimes convenient to make diagrams for all stress resultants even though some of them are not significant in the flexibility,  $G$ .

There are usually an unlimited number of possible primary systems. In the foregoing, the one selected has been denoted by  $X$ .

Let  $Y \equiv \{Y_1, Y_2, \dots, Y_n\}$  denote another.

Now, a pair of possible primary systems are linked by a linear transformation:

$$Y = HX \quad (38)$$

$$\text{i.e. } \frac{\partial Y_i}{\partial X_j} = h_{ij}$$

This means, simply that in the  $X$  system, when the equal and opposite pair,  $X_j = 1$  (all the other components being zero), then the value of the stress resultant in the frame at the position and direction of  $Y_i$  is equal to  $h_{ij}$ .

In most examples, the linking transformation is already given, either in the  $X$  system from the diagrams for  $\bar{x} = AX$ , or in the  $Y$  system from the diagrams for  $\bar{x} = BY$ . In the latter case, of course, the components of the reverse transformation,  $X = H^{-1}Y$ , are obtained.

When it is difficult to visualize that a proposed primary system,  $X$ , satisfies the conditions of being stable and determinate, a readily applied test is to set up an obviously legitimate primary system,  $Y$ , and to find whether the linking transformation is non-singular. The latter is the condition for the existence of the reciprocal,  $H^{-1}$ , and means that the determinant of the matrix,  $|H| \neq 0$ . That this transformation is necessarily reversible, is another way of stating that the number of redundants in a given structure is the same in all possible primary systems.

In the  $X$  system, the statement which eliminated the discontinuities was, in effect that

$$0 = \int A'\bar{G}\bar{x}^o ds + \int A'\bar{G}AdX \quad (39)$$

and was based on the transformation  $\bar{x} = AX$ .

In the  $Y$  system  $\bar{x} = BY$ , which, by making use of the linking transformation,  $Y = HX$ , becomes  $\bar{x} = BHX$ , so that manifestly  $A = BH$ .

When the latter substitution is made in Equation 39 the statement becomes

$$0 = H' \int B'\bar{G}\bar{x}^o ds + H' \int B'\bar{G}BdsHX \quad (40)$$

$$\text{i.e. } 0 = \int B'\bar{G}\bar{x}^o ds + \int B'\bar{G}BdsY$$

Although in Equation 40 the flexibility matrix,  $G = \int B'\bar{G}Bds$ , is now that of the  $Y$  system, this form of the statement is not the same as carrying out the analysis in that system because it contains unchanged the stress resultants,  $\bar{x}^o$ , arising from the loads in the  $X$  primary system.

In fact Equation 40 expresses the general theorem referred to at the end of the previous section, which may be enunciated as follows:

*For the purpose of linear analysis, stress resultants arising from loads applied to a structural frame may be given in any primary system, or combination of systems, not necessarily bearing any relation to that adopted for finding redundants.*

Thus, redundants supply the required corrections to equilibrium states obtained from any assumptions regarding rigidities which initiate stable and determinate conditions. Although the elimination of postulated discontinuities is merely a fiction, practical experience has shown that analysis carried out on the lines described obviates bother about sign conventions, which nearly always arises when what is being done is not perfectly clear cut.

The sundry results now given in the remainder of this section have been included for their own interest and to show that, when accompanied by clear thinking, a very powerful notation has been established for discussing the properties of structural frames.

Consider two sets of forces applied to a statically determinate frame: The first is denoted by  $X$ , its corresponding displacements by  $U$ , and has relevant transformations;

$$\bar{x} = AX$$

$$dU = A'd\bar{u}$$

The second is denoted by  $P$ , its corresponding displacements by  $V$ , and has relevant transformation;

$$\bar{x} = CP$$

$$dV = C'd\bar{u}$$

By introducing the elastic relation,  $d\bar{u} = \bar{G}\bar{x}ds$ , the following results may be obtained:

Displacements in  $X$  directions due to  $P$  loads are:

$$U = \int A'd\bar{u} = \int A'\bar{G}\bar{x}ds = \int A'\bar{G}CdsP = G_{x,p}P$$

Displacements in  $P$  directions due to  $X$  loads are:

$$V = \int C'd\bar{u} = \int C'\bar{G}\bar{x}ds = \int C'\bar{G}AdX = G_{p,x}X$$

The meaning of the now introduced mixed flexibility matrices is apparent and so is the fact that one is the transpose of the other, i.e.

$$G'_{p,x} = G_{x,p}$$

If the above mentioned determinate frame is actually a primary system, and  $X$  its redundant set, these results may be further extended.

Due to the  $P$  loads the redundants are given by

$$0 = \int A'\bar{G}CdsP + \int A'\bar{G}AdX$$

$$\text{i.e. } 0 = G_{x,p}P + G_{x,x}X$$

$$\text{or } X = -G_{x,x}^{-1}G_{x,p}P$$

and the displacements in the  $P$  directions comprise two parts: those due to the  $P$  loads and the  $X$  loads in the primary system:

$$V = \int C'\bar{G}CdsP + \int C'\bar{G}AdX$$

$$= G_{p,p}P + G_{p,x}X$$

$$= G_{p,p}P - G'_{x,p}G^{-1}_{x,x}G_{x,p}P$$

If attention be now concentrated on any one current point, its set of stress resultants may be expressed as a direct relation with the  $P$  loads,

$$\bar{x} = \bar{x}^o + AX$$

$$= CP - AG^{-1}_{x,x}G_{x,p}P$$

$$= \{C - AG^{-1}_{x,x}G_{x,p}\}P$$

Suppose  $\bar{u}$  is a set of forced displacements at the current point of the type illustrated in Fig. 6. In an indeterminate structure these will set up stresses in the members. However, in the primary system, the displacements in the  $P$  directions are

$$V = C'\bar{u}$$

and the relative displacements in the  $X$  directions are

$$U = A'\bar{u}$$

Now, if  $\bar{u}$  remains constant, but  $U$  is eliminated by the application of redundants, the latter are given by

$$0 = A'\bar{u} + G_{x,x}X$$

$$\text{i.e. } X = -G_{x,x}^{-1}A'\bar{u}$$

so, again, the displacements in the  $P$  directions comprise two parts: those due to the  $\bar{u}$  displacements and the  $X$  loads on the primary system:

$$V = C'\bar{u} + G_{p,x}X$$

$$= C'\bar{u} - G'_{x,p}G_{x,x}^{-1}A'\bar{u}$$

$$= \{C' - G'_{x,p}G_{x,x}^{-1}A'\}\bar{u}$$

Comparing this with the last expression for  $\bar{x}$  it is evident that  $\bar{x}$  and  $\bar{u}$ , and hence  $\bar{x}$  and  $d\bar{u}$ , are contragredient sets in indeterminate as well as determinate structures.

The last consideration leads at once to stress resultants arising from temperature changes of a statically indeterminate frame.

Assume that the temperature distribution over a cross-section of a member is linear.

Let  $t_1$  denote the temperature change at the longitudinal axis, and  $t_2$  the temperature gradient at right angles to one of the principal axes. In the primary system the corresponding distortions in a short axial length are:

$$\text{Direct} \quad \dots \quad d\bar{u}_1^0 = \epsilon t_1 ds$$

$$\text{Flexural} \quad \dots \quad d\bar{u}_2^0 = \epsilon t_2 ds$$

when  $\epsilon$  denotes the coefficient of expansion of the structural material. These temperature distortions may be denoted by  $d\bar{u}^0 = \epsilon t ds$  and give rise to relative displacements in the redundant set amounting to

$$U_i^0 = \epsilon \int A' t ds$$

The relative displacements are eliminated by the application of redundants,  $X_i$ , in the following simultaneous equations:

$$U_i^0 + GX_i = 0$$

When the redundants have been found, the stress resultants at a current point are

$$\bar{x}_i = AX_i$$

It is apparent that in analysis, the absolute values of elastic constants are required only for the calculation of temperature stresses and actual displacements.

#### A method of solving symmetric linear equations

In the simultaneous equations of Equation 35,  $U^0 + GX = 0$  the components of  $G$  and  $U^0$  are termed *influence coefficients*,\* and the components of  $X$  are the redundants.

It is convenient to let  $U = -U^0$ , so that the equations may be written:

$$GX = U \quad (41)$$

or, at length

$$\begin{bmatrix} g_{11} & g_{12} & g_{13} & \dots & g_{1n} \\ g_{21} & g_{22} & g_{23} & \dots & g_{2n} \\ g_{31} & g_{32} & g_{33} & \dots & g_{3n} \\ \dots & \dots & \dots & \dots & \dots \\ g_{n1} & g_{n2} & g_{n3} & \dots & g_{nn} \end{bmatrix} \begin{bmatrix} X_1 \\ X_2 \\ X_3 \\ \dots \\ X_n \end{bmatrix} = \begin{bmatrix} U_1 \\ U_2 \\ U_3 \\ \dots \\ U_n \end{bmatrix}$$

The vectors  $X$  and  $U$  are contragredient sets, and the matrix,  $G$ , is symmetric, i.e.  $g_{ki} = g_{ik}$ .

It has been shown that when another redundant set,  $x$ , is related to the first by the linear transformation:  $X = Hx$ ,

$$\text{then } u = H'U$$

$$\text{so that } GX = U$$

$$\text{becomes } H'GHx = H'U = u$$

$$\text{i.e. when } H'GH = E \text{ then } Ex = u$$

\* Ostenfeld and others who have developed structural theory on the lines initiated by Müller-Breslau, have used the symbols  $\delta_{jk}$  and  $\delta_{\sigma jk}$ , respectively, for these influence coefficients. Departures from well-established notations should not be made without very good reasons, but for this case the author believes the following are sufficient.

The symbol  $\delta_{jk}$  is universally recognized as the Kronecker delta (a very useful symbol which, however, has not been found necessary in this paper). By analogy with other fields of investigation, the fundamental matrix has been denoted by  $G$  and its components by  $g_{jk}$ . Greek letters are for the most part unsuitable for this correspondence between a capital and lower case with subscripts.

The influence coefficient,  $g_{jk}$ , never appears without subscripts and cannot, therefore, be confused with the gravitational constant. Admittedly, the overlapping of symbols is awkward. When gravity appears in the same context as  $g_{jk}$  the author advocates that it should be printed in roman type.

The method of solution to be described\* consists, in essence, of transforming the set of equations into one whose matrix is a diagonal matrix:

$$Ex = u \quad (42)$$

or, at length

$$\begin{bmatrix} e_1 & & & & \\ & e_2 & & & \\ & & e_3 & & \\ & & & \dots & \\ & & & & e_n \end{bmatrix} \begin{bmatrix} x_1 \\ x_2 \\ x_3 \\ \dots \\ x_n \end{bmatrix} = \begin{bmatrix} u_1 \\ u_2 \\ u_3 \\ \dots \\ u_n \end{bmatrix}$$

where

$$E^{-1} \equiv \begin{bmatrix} e^{-1} & & & & \\ & e_2^{-1} & & & \\ & & e_3^{-1} & & \\ & & & \dots & \\ & & & & e_n^{-1} \end{bmatrix}$$

Since the whole of an isolating transformation cannot in general be given a physical interpretation, the solution process, stated in principle in the following steps, should be regarded as a purely arithmetical device to be carried out in the most convenient way.

(a) Find a transformation which makes  $E = H'GH$  into a diagonal matrix.

$$(b) u = H'U$$

$$(c) x = E^{-1}u$$

$$(d) X = Hx$$

Any repetition in the shape of a structure may be exploited in its analysis, but apart from this the most convenient type of isolation transformation is a triangular matrix with units in its leading diagonal. To clear the non-diagonal elements of  $G$ , row and column by row and column, only the individual members of a product of such triangular matrices need be determined.

$$\text{Let } H = H_1 H_2 H_3 \dots H_{n-1} \quad (43)$$

where in  $H_k$  the only non-zero elements are the leading diagonal of units, and in the  $k$ th row above the diagonal, e.g.

$$H_1 = \begin{bmatrix} 1 & a_{12} & a_{13} & \dots & a_{1n} \\ & 1 & & & \\ & & 1 & & \\ & & & \dots & \\ & & & & 1 \end{bmatrix} \equiv I + A_1$$

$$H_2 = \begin{bmatrix} 1 & & & & \\ & 1 & a_{23} & a_{24} & \dots & a_{2n} \\ & & 1 & & & \\ & & & \dots & & \\ & & & & 1 & \\ & & & & & \dots & \\ & & & & & & 1 \end{bmatrix} \equiv I + A_2$$

By trying an example it will be seen that these matrices have the

\* It is one method taken from a more expansive exposition given in an appendix to, an earlier publication<sup>3</sup> by the author, dealing with the application of distribution methods to another class of structure, and requiring the solution of linear simultaneous equations and the reciprocal of a symmetric positive definite matrix. A treatment, in matrix terms, of simultaneous equations in general has been given by Fox<sup>4</sup>.

special property that  $H_k^{-1} = I - A_k$  and the reciprocal of the product is:

$$H^{-1} = \begin{bmatrix} 1 & -a_{12} & -a_{13} & \dots & \dots & \dots & -a_{1n} \\ & 1 & -a_{23} & \dots & \dots & \dots & -a_{2n} \\ & & 1 & \dots & \dots & \dots & -a_{3n} \\ & & & \dots & \dots & \dots & \\ & & & & & & 1 \end{bmatrix} \quad (44)$$

and hence the step enumerated (b) above becomes

$$U = H^{-1}u \quad (45)$$

and is carried out by making use of the previous results at each stage:

$$\begin{bmatrix} U_1 \\ U_2 \\ U_3 \\ U_4 \end{bmatrix} = \begin{bmatrix} 1 & & & \\ -a_{12} & 1 & & \\ -a_{13} & -a_{23} & 1 & \\ -a_{14} & -a_{24} & -a_{34} & 1 \end{bmatrix} \begin{bmatrix} u_1 \\ u_2 \\ u_3 \\ u_4 \end{bmatrix} \quad \begin{array}{l} \therefore u_1 = U_1 \\ u_2 = a_{12}u_1 + U_2 \\ u_3 = a_{13}u_1 + \\ \quad a_{23}u_2 + U_3 \\ \downarrow \text{ and so on} \end{array}$$

Similarly the step enumerated in (d) becomes:

$$x = H^{-1}X \quad (46)$$

and works in the reverse direction. It is conveniently depicted by assuming eight simultaneous equations:

$$\begin{bmatrix} x_5 \\ x_6 \\ x_7 \\ x_8 \end{bmatrix} = \begin{bmatrix} 1 & -a_{56} & -a_{57} & -a_{58} \\ & 1 & -a_{67} & -a_{68} \\ & & 1 & -a_{78} \\ & & & 1 \end{bmatrix} \begin{bmatrix} X_5 \\ X_6 \\ X_7 \\ X_8 \end{bmatrix} \quad \begin{array}{l} \uparrow \text{ and so on} \\ X_6 = x_6 + a_{67}X_7 \\ \quad + a_{68}X_8 \\ X_7 = x_7 + a_{78}X_8 \\ X_8 = x_8 \end{array}$$

Step (a) has already been described for an order of  $3 \times 3$  in the discussion of direct stresses over an unsymmetrical cross-section.

In general terms

$$E = H_{n-1}^{-1} \dots H_2^{-1} H_1^{-1} G H_1 H_2 \dots H_{n-1} \quad (47)$$

The first diagonal element is not modified, i.e.  $e_1 = g_{11}$

Working from the centre outwards:

$$(1) \quad G^{(2)} = H_1^{-1} G H_1 \quad (48)$$

The first row and column are cleared when

$$a_{12} = -e_1^{-1} g_{12}; \quad a_{13} = -e_1^{-1} g_{13}; \quad a_{14} = -e_1^{-1} g_{14} \quad \dots \quad \text{etc.}$$

The rest of the matrix is then modified by

$$g_{ik}^{(2)} = g_{ik} + a_{1i} g_{1k}$$

and, in particular,

$$e_2 = g_{22} + a_{12} g_{21}$$

and

$$g_{33}^{(2)} = g_{33} + a_{13} g_{31}$$

$$(2) \quad G^{(3)} = H_2^{-1} G^{(2)} H_2 \quad (49)$$

The second row and column are cleared when

$$a_{23} = -e_2^{-1} g_{23}^{(2)}; \quad a_{24} = -e_2^{-1} g_{24}^{(2)}; \quad a_{25} = \dots \quad \text{etc.}$$

The rest of the matrix is then modified by

$$g_{ik}^{(3)} = g_{ik}^{(2)} + a_{2i} g_{2k}^{(2)} \\ = g_{ik} + a_{1i} g_{1k} + a_{2i} g_{2k}^{(2)}$$

and, in particular,

$$e_3 = g_{33}^{(2)} + a_{23} g_{32}^{(2)} \\ = g_{33} + a_{13} g_{31} + a_{23} g_{32}^{(2)}$$

$$(3) \quad G^{(4)} = H_3^{-1} G^{(3)} H_3 \quad (50)$$

The third row and column are cleared when

$$a_{34} = -e_3^{-1} g_{34}^{(3)}; \quad a_{35} = -e_3^{-1} g_{35}^{(3)}; \quad a_{36} = \dots$$

The rest of the matrix is then modified by

$$g_{ik}^{(4)} = g_{ik}^{(3)} + a_{3i} g_{3k}^{(3)} \\ = g_{ik} + a_{1i} g_{1k} + a_{2i} g_{2k}^{(2)} + a_{3i} g_{3k}^{(3)} \quad (i > 3) \\ (k > 3)$$

This expression shows that the modification of what remains of a given row can be left until it is the turn of its own leading element to be isolated.

In particular,

$$e_4 = g_{44} + a_{14} g_{14} + a_{24} g_{24}^{(2)} + a_{34} g_{34}^{(3)}$$

Because  $G$  is positive definite, all the diagonal elements of  $E$  will be positive, although their modification terms are all subtractions, as may be shown from the last expression, which is equivalent to

$$e_4 = g_{44} - e_1^{-1} g_{14} g_{14} - e_2^{-1} g_{24}^{(2)} g_{24}^{(2)} - e_3^{-1} g_{34}^{(3)} g_{34}^{(3)}$$

The systematic solution of simultaneous linear equations may be set out in tabular arrangement. The method described is shown in Table 1, where an assumed order of  $5 \times 5$  illustrates any order.

Except for the descriptive column on the left of Table 1, all entries should be numerical. It is a good idea to enter the  $a_{ij}$  rows in ink or a different colour to make them stand out from the rest.

Some means must be adopted to avoid carrying forward numerical errors. With a calculating machine and orders up to about  $6 \times 6$  very little extra time is used in doing each calculation twice. Otherwise checks by summing rows or columns may be employed<sup>4</sup>. The first thing to do, of course, is to make sure that the influence coefficients are all present and correct.

Notes about choosing primary systems to make the solution as rapid as possible have been left to the last section of the paper. Here it is pertinent to say, without going minutely into matters where experience is the best instructor, that scalar factors which are estimated to make the elements of  $E$  average near unity, should be introduced if necessary.

The final check consists of evaluating  $U = GX$  by back substitution, and may show that up to two significant figures have been lost — another general reason why a slide rule is an inappropriate instrument for this class of work.

### An illustrative worked example

For a given structure, the preliminary work of evaluating influence coefficients has to be carried out particularly and severally for each member and each type of significant distortion. It was in reference to this aspect that the analysis of frames was described as a discrete problem.

For this purpose the matrix expressions,

$$G = \int A' \bar{G} A ds$$

$$U_i^0 = \int A' \bar{G} \bar{x}_i^0 ds$$

have to be 'unwrapped' and in doing this the use of the summation convention,

$$g_{ik} = \int a_{ni} \bar{g}_{ni} a_{nk} ds$$

$$U_i^0 = \int a_{ni} \bar{g}_{ni} \bar{x}_j^0 ds$$

was explained. If  $\bar{G}$  is a diagonal matrix and there are, for example, two types of significant distortions, the several terms are as follows:

$$g_{ik} = \int a_{1i} \bar{g}_{11} a_{1k} ds + \int a_{2i} \bar{g}_{22} a_{2k} ds \quad (51)$$

$$U_i^0 = \int a_{1i} \bar{g}_{11} \bar{x}_1^0 ds + \int a_{2i} \bar{g}_{22} \bar{x}_2^0 ds \quad (52)$$

These triple products may be found at as many current points as desired but often they cannot be expressed as an integrable function along a member. In that case a method of numerical integration has to be employed. Provided a sufficient number of intervals are taken, Simpson's rule is the best and entails less work than the trapezoidal rule. It is also suggested that Simpson's rule is to be preferred whenever functional integration is at all difficult or complicated.

However, when a member is straight and has a uniform cross section, as in the example which follows, it is very convenient to find beforehand the easily remembered factors appearing in integrations of products of pairs of linear functions and products of linear with parabolic functions. These simple integrations have been in use for many years and are to be found elsewhere, but because they are soon dealt with and are employed in the present numerical example, some of them are given in Table 2 on page 22.

When the product of the two general linear functions, shown diagrammatically in the first row of Table 2, is integrated over the length,  $l$ ,

$$\text{since} \quad m = \frac{l-s}{l} m_1 + \frac{s}{l} m_2$$

$$\text{and} \quad n = \frac{l-s}{l} n_1 + \frac{s}{l} n_2$$

$$\text{then} \quad \int_0^l m n ds = \frac{1}{6} l (2m_1 n_1 + m_1 n_2 + m_2 n_1 + 2m_2 n_2)$$

From this, the other linear pairs in Table 2 are obvious. Some linear parabolic integrations are given at the bottom of the table.

All that is latent in a generalized theoretical treatment cannot be brought out in a single example, still less in a simple case where the numerical working of all classical methods comes very much to the same thing. However, the last is an important point to retain at this stage in a progressive exposition.

The unsymmetrical plane frame, chosen for the worked example, is shown in the diagram of Fig. 14, which also gives the symbols used for the dimensional layout of the centroidal axes of the members and the moments of inertia,  $I$ , and areas,  $A$ , of their cross-sections. The particular numerical values of these symbols, stated below the

**Table 1**  
Scheme for solution of symmetric equation:  $GX = U$

|               | 1  | 2  | 3  | 4  | 5  |
|---------------|--|--|--|--|--|
| $g_1$         | $g_{11}$   | $g_{12}$   | $g_{13}$   | $g_{14}$   | $g_{15}$   |
| $a_1$         | $e_1^{-1} = g_{11}^{-1}$   | $a_{12} = -e_1^{-1}g_{12}$                                       | $a_{13} = -e_1^{-1}g_{13}$                         | $a_{14} = -e_1^{-1}g_{14}$   | $a_{15} = -e_1^{-1}g_{15}$   |
| $g_2$         |  | $g_{22}$<br>$a_{12}g_{12}$                                       | $g_{23}$<br>$a_{12}g_{13}$                         | $g_{24}$<br>$a_{12}g_{14}$   | $g_{25}$<br>$a_{12}g_{15}$   |
| $g_2^{(2)}$   |  | $e_2$  | $g_{23}^{(2)}$                                     | $g_{24}^{(2)}$   | $g_{25}^{(2)}$   |
| $a_2$         |  | $e_2^{-1}$   | $a_{23} = -e_2^{-1}g_{23}^{(2)}$                   | $a_{24} = -e_2^{-1}g_{24}^{(2)}$   | $a_{25} = -e_2^{-1}g_{25}^{(2)}$   |
| $g_3$         |  |  | $g_{33}$<br>$a_{13}g_{13}$<br>$a_{23}g_{23}^{(2)}$ | $g_{34}$<br>$a_{13}g_{14}$<br>$a_{23}g_{24}^{(2)}$                         | $g_{35}$<br>$a_{13}g_{15}$<br>$a_{23}g_{25}^{(2)}$   |
| $g_3^{(3)}$   |  |  | $e_3$  | $g_{34}^{(3)}$   | $g_{35}^{(3)}$   |
| $a_3$         |  |  | $e_3^{-1}$   | $a_{34} = -e_3^{-1}g_{34}^{(3)}$   | $a_{35} = -e_3^{-1}g_{35}^{(3)}$   |
| $g_4$         |  |  |  | $g_{44}$<br>$a_{14}g_{14}$<br>$a_{24}g_{24}^{(2)}$<br>$a_{34}g_{34}^{(3)}$ | $g_{45}$<br>$a_{14}g_{15}$<br>$a_{24}g_{25}^{(2)}$<br>$a_{34}g_{35}^{(3)}$                         |
| $g_4^{(4)}$   |  |  |  | $e_4$  | $g_{45}^{(4)}$   |
| $a_4$         |  |  |  | $e_4^{-1}$   | $a_{45} = -e_4^{-1}g_{45}^{(4)}$   |
| $g_5$         |  |  |  |  | $g_{55}$<br>$a_{15}g_{15}$<br>$a_{25}g_{25}^{(2)}$<br>$a_{35}g_{35}^{(3)}$<br>$a_{45}g_{45}^{(4)}$ |
| $g_5^{(5)}$   |  |  |  |  | $e_5$  |
|               |  |  |  |  | $e_5^{-1}$   |
| $U = -U^o$    | $U_1$  | $U_2$<br>$a_{12}U_1$   | $U_3$<br>$a_{13}U_1$<br>$a_{23}U_2$                | $U_4$<br>$a_{14}U_1$<br>$a_{24}U_2$<br>$a_{34}U_3$                         | $U_5$<br>$a_{15}U_1$<br>$a_{25}U_2$<br>$a_{35}U_3$<br>$a_{45}U_4$                                  |
| $u$           | $u_1$  | $u_2$  | $u_3$  | $u_4$  | $u_5$  |
| $x = E^{-1}u$ | $x_1 = -e_1^{-1}u_1$<br>$a_{12}x_2$<br>$a_{13}x_3$<br>$a_{14}x_4$<br>$a_{15}x_5$ | $x_2 = e_2^{-1}u_2$<br>$a_{23}x_3$<br>$a_{24}x_4$<br>$a_{25}x_5$ | $x_3 = e_3^{-1}u_3$<br>$a_{34}x_4$<br>$a_{35}x_5$  | $x_4 = e_4^{-1}u_4$<br>$a_{45}x_5$   | $x_5 = e_5^{-1}u_5$  |
| $X$           | $X_1$  | $X_2$  | $X_3$  | $X_4$  | $X_5$  |

diagram, are not required until after the influence coefficients have been found in general terms.

The significant distortions are assumed to be flexure and extension. Young's modulus may be omitted because relative flexibilities only are required, and therefore in this case, worked in centroidal axes, it is sufficient to put at a current point:

$$\bar{G} \equiv \begin{bmatrix} \bar{g}_{11} & & \\ & \bar{g}_{22} & \\ & & \end{bmatrix} \quad \text{where } \bar{g}_{11} = \frac{1}{I} \\ \bar{g}_{22} = \frac{1}{A}$$

Except when multiplicity makes it inconvenient, no departure is proposed in practice from the readily identified conventional symbols for stress resultants, and in this example,

$$\bar{x} \equiv \{\bar{x}_1 \bar{x}_2 \bar{x}_3\} \equiv \{M N Q\}$$

where  $M$  denotes bending moment  
 $N$  „ direct force  
 $Q$  „ shear force

However, it should be appreciated that their order of expression has already been determined by the order adopted for  $\bar{G}$ , and that they are components of vectors or matrices which specify the pattern of their arrangement. To be quite clear on this point, when  $M_i$ ,  $N_i$  and  $Q_i$  are severally defined according to the scheme set out on page 16, the transformation  $\bar{x} = AX$  has the equivalent forms:

$$A \equiv \begin{bmatrix} a_{11} & a_{12} & a_{13} & \dots \\ a_{21} & a_{22} & a_{23} & \dots \\ a_{31} & a_{32} & a_{33} & \dots \end{bmatrix} \equiv \begin{bmatrix} M_1 & M_2 & M_3 & \dots \\ N_1 & N_2 & N_3 & \dots \\ Q_1 & Q_2 & Q_3 & \dots \end{bmatrix} \quad (53)$$

and, since each member has a constant cross-section, the equivalents **21**

|  |  |   |
|--|--|---|
|  |  | Integral: $\int_0^l m n ds$                           |
|  |  | $\frac{1}{2} l (2m_1n_1 + m_1n_2 + m_2n_1 + 2m_2n_2)$ |
|  |  | $l m n$   |
|  |  | $\frac{3}{2} l m n$                                   |
|  |  | $\frac{3}{2} l m n$                                   |
|  |  | $\frac{1}{2} l m n$                                   |
|  |  | $\frac{3}{2} l (m_1 + m_2) n$                         |
|  |  | $\frac{1}{2} l (2m_1 + m_2) n$                        |
|  |  | $\frac{1}{2} l m n$                                   |
|  |  | $\frac{1}{2} l m n$                                   |

Table 2

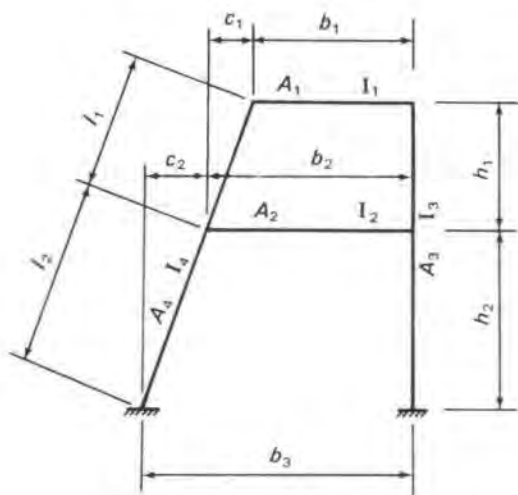

|                            |                                 |
|----------------------------|---------------------------------|
| $b_1 = 90 \text{ in}$      | $A_3 = 44.12 \text{ in}^2$      |
| $b_2 = 150 \text{ in}$     | $A_4 = 55.88 \text{ in}^2$      |
| $b_3 = 240 \text{ in}$     | $k_1 = \frac{b_1}{b_2} = 0.6$   |
| $h_1 = 240 \text{ in}$     | $k_2 = \frac{b_2}{b_3} = 0.625$ |
| $h_2 = 360 \text{ in}$     | $I_1 = 2452.34 \text{ in}^4$    |
| $l_1 = 247.39 \text{ in}$  | $I_2 = 1683.52 \text{ in}^4$    |
| $l_2 = 371.08 \text{ in}$  | $I_3 = 3353.60 \text{ in}^4$    |
| $c_1 = 60 \text{ in}$      | $I_4 = 5066.48 \text{ in}^4$    |
| $c_2 = 90 \text{ in}$      |                                 |
| $A_1 = 38.24 \text{ in}^2$ |                                 |
| $A_2 = 32.36 \text{ in}^2$ |                                 |

Fig. 14

of Equations 52 and 53 are, respectively:

$$g_{ik} = \frac{1}{I} \int M_i M_k ds + \frac{1}{A} \int N_i N_k ds \quad \left. \begin{array}{l} \text{Summed} \\ \text{for all} \\ \text{members} \end{array} \right\} \quad (54)$$

$$U_j^o = \frac{1}{I} \int M_j M^o ds + \frac{1}{A} \int N_j N^o ds \quad (55)$$

the shear distortions having been neglected.

The first part of the analysis, that is to the completion of the upper half of Table 1, is independent of the loading.

The primary system adopted is the simple one obtained by postulating two complete cuts in the positions shown in Fig. 15.

The sketch diagrams, given in Fig. 16, for the linear transformation,  $\bar{x} = AX$ , relating stress resultants with a redundant set, are positionally arranged to correspond with the components of  $A'$ . The following points are noted:

Shear force diagrams have been included, although not required for influence coefficients. In more complicated cases the complete set of diagrams is a great help in the final steps of the analysis;

In the components of  $X$  a convenient linear dimension has been combined with each of the four direct forces to make them dimensionally consistent with the two couples;

The diagrams unambiguously define the sign conventions adopted for each stress resultant in each member. Any conventions will do provided they are used consistently.

By taking all the values of  $i$  and  $k$  of Equation 54 from 1, 2, . . . . . 6, and making use of the integration formulas of Table 2, the components of  $G$  are expressed in general terms in Table 3.

The corresponding numerical table (Table 4) presents another opportunity of saving time and writing by accumulating products in a machine. The extensional parts are relatively insignificant in this example.

The upper half of Table 7 is the numerical equivalent, for the example, of the upper half of Table 1.

The second part of the analysis is the completion of the lower half of Table 1. For this example two typical loads,  $F_1$  and  $F_2$ , have been considered. In practice separate solutions have to be found to account for all possible load combinations, but for the purpose of the example the two loads are assumed to act together and different primary systems have been used for each, as shown in Fig. 17 and 18.

Although the chosen primary systems have the advantage of minimizing the numerical work in finding influence coefficients, that for  $F_1$  has certain disadvantages. Having seen that the solution process is essentially that of correcting the stress distribution of the primary system, it is evident that the nearer the latter is to the actual distribution, the fewer the number of significant figures required in solving the equations.

Table 5 gives the  $U^o$  components in general terms and numerically in Table 6. The lower half of Table 7 is the numerical equivalent, for the example, of the lower half of Table 1.

The last part of the analysis is that of finding stress resultants throughout the structure (see (h) on page 18). Fig. 19 shows the points at which stress resultants are to be found. To make it quite clear that all the information required has already been set out, the work of finding  $\bar{x} = \bar{x}^o + AX$ , is given in general terms in Table 8 and numerically in Table 9.

Fig. 20 consists of diagrams for the bending stress resultants in this statically indeterminate structure due to the loadings stated.

The tabulation of influence coefficients is merely that which seems convenient for this particular example, but it should be noted that it has been carried forward as long as possible in the form of external multipliers into dimensionless ratios.

The example will now be used to demonstrate the statement that all possible redundant systems are linearly linked.

Primary systems for worked example



Fig. 15

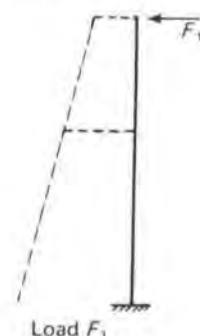

Fig. 17

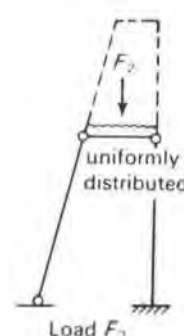

Fig. 18

Let  $Y \equiv \{Y_1, Y_2, Y_3, \dots, Y_6\}$  be a redundant system of the all hinge type shown in Fig. 21.

The transformation  $Y = HX$  may be read off from the first column of Fig. 16:

$$\begin{bmatrix} Y_1 \\ Y_2 \\ Y_3 \\ Y_4 \\ Y_5 \\ Y_6 \end{bmatrix} = \begin{bmatrix} 1 & & & & & \\ & 1 & 1 & & & \\ & & & 1 & & \\ & & & & 1 & 1 \\ & & & & & 1 & 1 \end{bmatrix} \begin{bmatrix} X_1 \\ X_2 \\ X_3 \\ X_4 \\ X_5 \\ X_6 \end{bmatrix}$$

$\therefore |H| = 1$  and in  $X = H^{-1}Y$ :

$$H^{-1} = \begin{bmatrix} 1 & -1 & -1 & & & \\ & 1 & & & & \\ & & 1 & & & \\ & & & 1 & -1 & -1 \\ & & & & 1 & \\ & & & & & 1 \end{bmatrix}$$

From Fig. 16 it would be a simple matter to obtain the set of diagrams  $\bar{x} = BY$  from  $\bar{x} = AX = AH^{-1}Y$ , that is,  $B' = H^{-1}A'$ . In some respects it would be simpler to do it this way instead of directly.

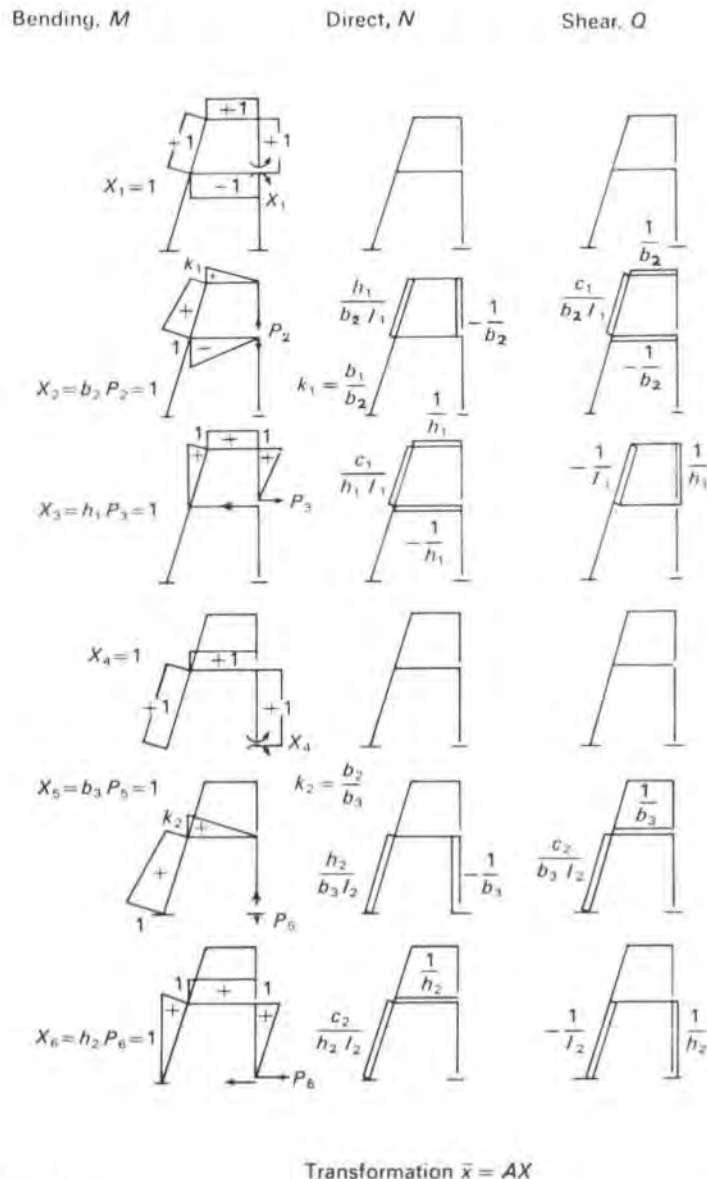

Fig. 16

A reason sometimes advanced for using a redundant system of couples only is that when the redundants all have the same dimensions, the coefficients are not a mixture of large and small numbers. However, it has been shown that this dimensional difficulty can be dealt with by combining a linear dimension with a redundant.

**General considerations**

What may be described as the art of analysis by the Classical Theory largely consists of choosing the most convenient primary systems for redundants and loads. Because the primary systems for the two sides of the equation need not be the same, their general principles may be considered separately.

With regard to the load system, it has already been stated that the smaller the analytical correction (i.e. as  $X \rightarrow 0$ ) the fewer the number of significant figures required. Against this must be balanced the desirability of making the components of  $U^o$  as simple as possible, bearing in mind that the evaluation of influence coefficients is the greater part of the work and that a few more significant figures are of small consequence when a calculating machine is used.

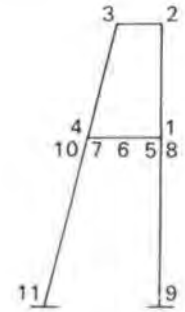

Fig. 19  
Positions for stress resultants

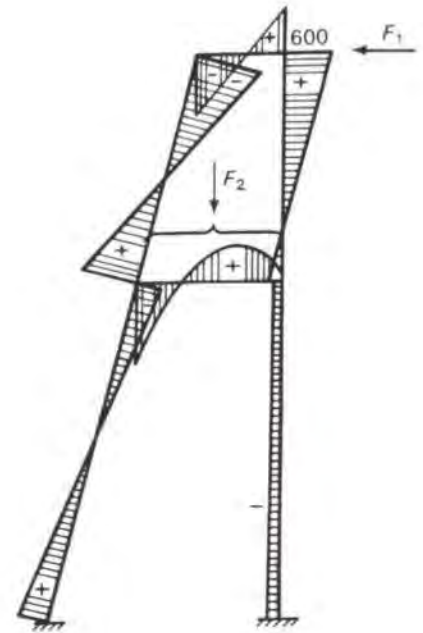

Fig. 20  
Bending moments for values of  $F_1$  and  $F_2$  taken in worked example

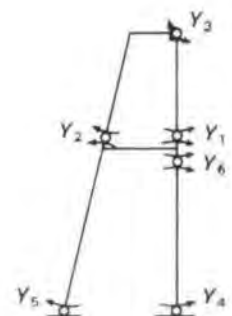

Fig. 21  
Alternative redundant system

**Table 3**  
Influence coefficients

| Bending  |                    |                    |                            |                            | Extension                        |  |                                  |                                  |
|----------|--------------------|--------------------|----------------------------|----------------------------|----------------------------------|--|----------------------------------|----------------------------------|
| Factor:  | $\frac{rb_1}{I_1}$ | $\frac{rb_2}{I_2}$ | $\frac{rh_1}{I_3}$         | $\frac{rI_1}{I_4}$         | $\frac{r}{b_1A_1}$               | $\frac{r}{b_2A_2}$                       | $\frac{r}{h_1A_3}$               | $\frac{r}{I_1A_4}$               |
| $g_{11}$ | 1                  | 1                  | 1                          | 1                          | .                                | .  | .                                | .                                |
| $g_{12}$ | $\frac{1}{2}k_1$   | $\frac{1}{2}$      | .                          | $\frac{1}{2}(1+k_1)$       | .                                | .  | .                                | .                                |
| $g_{13}$ | 1                  | .                  | $\frac{1}{2}$              | $\frac{1}{2}$              | .                                | .  | .                                | .                                |
| $g_{14}$ | .                  | -1                 | .                          | .                          | .                                | .  | .                                | .                                |
| $g_{15}$ | .                  | $-\frac{1}{2}k_2$  | .                          | .                          | .                                | .  | .                                | .                                |
| $g_{16}$ | .                  | -1                 | .                          | .                          | .                                | .  | .                                | .                                |
| $g_{22}$ | $\frac{1}{3}k_1^2$ | $\frac{1}{3}$      | .                          | $\frac{1}{3}(1+k_1+k_1^2)$ | .                                | .  | $\left(\frac{h_1}{b_2}\right)^2$ | $\left(\frac{h_1}{b_2}\right)^2$ |
| $g_{23}$ | $\frac{1}{2}k_1$   | .                  | .                          | $\frac{1}{6}(1+2k_1)$      | .                                | .  | .                                | $c_1/b_2$                        |
| $g_{24}$ | .                  | $-\frac{1}{2}$     | .                          | .                          | .                                | .  | .                                | .                                |
| $g_{25}$ | .                  | $-\frac{1}{3}k_2$  | .                          | .                          | .                                | .  | .                                | .                                |
| $g_{26}$ | .                  | $-\frac{1}{2}$     | .                          | .                          | .                                | .  | .                                | .                                |
| $g_{33}$ | 1                  | .                  | $\frac{1}{3}$              | $\frac{1}{3}$              | $\left(\frac{b_1}{h_1}\right)^2$ | $\left(\frac{b_2}{h_1}\right)^2$         | .                                | $\left(\frac{c_1}{h_1}\right)^2$ |
| $g_{34}$ | .                  | .                  | .                          | .                          | .                                | .  | .                                | .                                |
| $g_{35}$ | .                  | .                  | .                          | .                          | .                                | .  | .                                | .                                |
| $g_{36}$ | .                  | .                  | .                          | .                          | .                                | $-\frac{b_2}{h_1} \cdot \frac{b_2}{h_2}$ | .                                | .                                |
| Factor:  | $\frac{rb_2}{I_2}$ | $\frac{rh_2}{I_3}$ | $\frac{rI_2}{I_4}$         |                            | $\frac{r}{b_2A_2}$               | $\frac{r}{h_2A_3}$                       |                                  | $\frac{r}{I_2A_4}$               |
| $g_{44}$ | 1                  | 1                  | 1                          |                            | .                                | .  |                                  | .                                |
| $g_{45}$ | $\frac{1}{2}k_2$   | .                  | $\frac{1}{2}(1+k_2)$       |                            | .                                | .  |                                  | .                                |
| $g_{46}$ | 1                  | $\frac{1}{2}$      | $\frac{1}{2}$              |                            | .                                | .  |                                  | .                                |
| $g_{55}$ | $\frac{1}{3}k_2^2$ | .                  | $\frac{1}{3}(1+k_2+k_2^2)$ |                            | .                                | $\left(\frac{h_2}{b_3}\right)^2$         |                                  | $\left(\frac{h_2}{b_3}\right)^2$ |
| $g_{56}$ | $\frac{1}{2}k_2$   | .                  | $\frac{1}{6}(1+2k_2)$      |                            | .                                | .  |                                  | $c_2/b_3$                        |
| $g_{66}$ | 1                  | $\frac{1}{3}$      | $\frac{1}{3}$              |                            | $\left(\frac{b_2}{h_2}\right)^2$ | .  |                                  | $\left(\frac{c_2}{h_2}\right)^2$ |

Where  $k_1 = \frac{b_1}{b_2}$ ,  $k_2 = \frac{b_2}{b_3}$  and  $r =$  common factor



**Table 4**  
Numerical counterpart of Table 3

$r = 10$

| Factor:  | 0.36700 | 0.89099  | 0.71565 | 0.48829 | 0.00290 | 0.00206  | 0.00094 | 0.00072 | Total   |
|----------|---------|----------|---------|---------|---------|----------|---------|---------|---------|
| $g_{11}$ | 1       | 1        | 1       | 1       | .       | .        | .       | .       | 2.4619  |
| $g_{12}$ | 0.3     | 0.5      | .       | 0.8     | .       | .        | .       | .       | 0.9462  |
| $g_{13}$ | 1       | .        | 0.5     | 0.5     | .       | .        | .       | .       | 0.9690  |
| $g_{14}$ | .       | -1       | .       | .       | .       | .        | .       | .       | -0.8910 |
| $g_{15}$ | .       | -0.3125  | .       | .       | .       | .        | .       | .       | -0.2784 |
| $g_{16}$ | .       | -1       | .       | .       | .       | .        | .       | .       | -0.8910 |
| $g_{22}$ | 0.12    | 0.33333  | .       | 0.65333 | .       | .        | 2.56    | 2.56    | 0.6643  |
| $g_{23}$ | 0.3     | .        | .       | 0.36667 | .       | .        | .       | 0.4     | 0.2894  |
| $g_{24}$ | .       | -0.5     | .       | .       | .       | .        | .       | .       | -0.4455 |
| $g_{25}$ | .       | -0.20833 | .       | .       | .       | .        | .       | .       | -0.1856 |
| $g_{26}$ | .       | -0.5     | .       | .       | .       | .        | .       | .       | -0.4455 |
| $g_{33}$ | 1       | .        | 0.33333 | 0.33333 | 0.14062 | 0.39062  | .       | 0.0625  | 0.7696  |
| $g_{34}$ | .       | .        | .       | .       | .       | .        | .       | .       | 0       |
| $g_{35}$ | .       | .        | .       | .       | .       | .        | .       | .       | 0       |
| $g_{36}$ | .       | .        | .       | .       | .       | -0.26042 | .       | .       | -0.0005 |

| Factor:  | 0.89099 | 1.07347 | 0.73242 | 0.00206 | 0.00063 | 0.00048 |        |
|----------|---------|---------|---------|---------|---------|---------|--------|
| $g_{44}$ | 1       | 1       | 1       | .       | .       | .       | 2.6969 |
| $g_{45}$ | 0.3125  | .       | 0.8125  | .       | .       | .       | 0.8735 |
| $g_{46}$ | 1       | 0.5     | 0.5     | .       | .       | .       | 1.7939 |
| $g_{55}$ | 0.13021 | .       | 0.67188 | .       | 2.25    | 2.25    | 0.6106 |
| $g_{56}$ | 0.3125  | .       | 0.375   | .       | .       | 0.375   | 0.5533 |
| $g_{66}$ | 1       | 0.33333 | 0.33333 | 0.17361 | .       | 0.0625  | 1.4933 |

With regard to the redundant system, an inspection of Table 1 makes it evident that there should be as many zero coefficients as possible and the numbering of the redundants should be such that the non-zero coefficients lie as close as possible to the leading diagonal.

Structures may be classified according to the layout of the matrix of coefficients of their optimum redundant systems. The theorem of Three Moments for continuous beams – the simplest type of statically indeterminate structure – exemplifies the simplest type of  $G$  matrix, called a *continuant*, having zero elements everywhere except in the leading diagonal and the next diagonals above and below it.

The structure of the  $G$  matrix is often most clearly exposed when it is partitioned into submatrices. Probably the largest class, in practice, is that in which the redundants may be so chosen as to give a *continuant* in submatrices. That is, when  $GX = U$  may be partitioned into:

$$\begin{bmatrix} G_{11} & G_{12} & . & . & . & . \\ G_{21} & G_{22} & G_{23} & . & . & . \\ . & G_{32} & G_{33} & G_{34} & . & . \\ . & . & G_{43} & G_{44} & G_{45} & . \\ . & . & . & G_{54} & G_{55} & G_{56} \\ . & . & . & . & G_{65} & G_{66} \end{bmatrix} \begin{bmatrix} X_1 \\ X_2 \\ X_3 \\ X_4 \\ X_5 \\ X_6 \end{bmatrix} = \begin{bmatrix} U_1 \\ U_2 \\ U_3 \\ U_4 \\ U_5 \\ U_6 \end{bmatrix} \quad (56)$$

The principal submatrices in the leading diagonal may each be of any square order from  $1 \times 1$  upwards. The orders of the other submatrices

will not necessarily be square and will fit in with the arrangement of the partitions.  $X$  and  $U$  will be conformably partitioned into column sub-vectors.

If there is some repetition of structural members so that certain groups of submatrices are identical, it would obviously be best to begin the solution by isolating these groups in one operation before proceeding with the rest of the isolation. Without going into matters too extensive for the present treatment, the type of isolating transformation employed may be explained by supposing that, in Equation 56, the two groups within the dotted lines, as shown below, are identical.

$$\begin{bmatrix} G_{11} & G_{12} & . & . & . & . \\ G_{21} & G_{22} & G_{23} & . & . & . \\ . & G_{32} & G_{33} & G_{34} & . & . \\ . & . & G_{43} & G_{44} & G_{45} & . \\ . & . & . & G_{54} & G_{55} & G_{56} \\ . & . & . & . & G_{65} & G_{66} \end{bmatrix} \quad (57)$$

The isolation of  $G_{22}$  and  $G_{55}$  are the one and the same operations which effects a condensation. Only the upper part, cut off by the full lines, need be considered in this case. Since further isolating operations are to follow, count of the stages is kept by a superscript in brackets.

**Table 5**

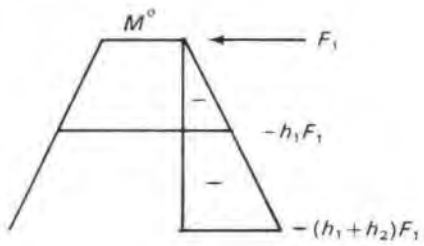

$N^o = 0$

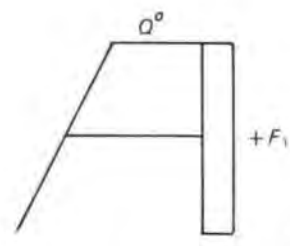

| Bending                      | Factor: $\frac{rh_1^2}{I_3}$                             |
|------------------------------|--|
| $U_1^o$                      | $-\frac{1}{2}$   |
| $U_2^o$                      | .  |
| $U_3^o$                      | $-\frac{1}{6}$   |
| Factor: $\frac{rh_2^2}{I_3}$ |  |
| $U_4^o$                      | $-\left(\frac{1}{2} + \frac{h_1}{h_2}\right)$            |
| $U_5^o$                      | .  |
| $U_6^o$                      | $-\frac{1}{3}\left(\frac{1}{3} + \frac{h_1}{h_2}\right)$ |

In terms of  $F_1$

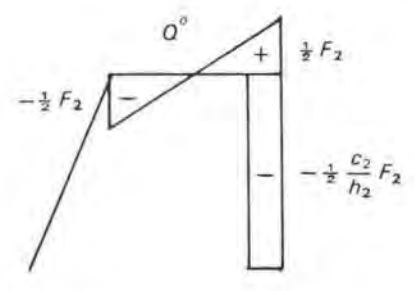
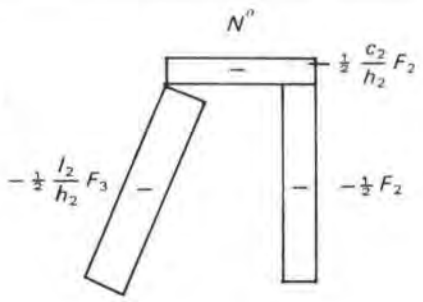
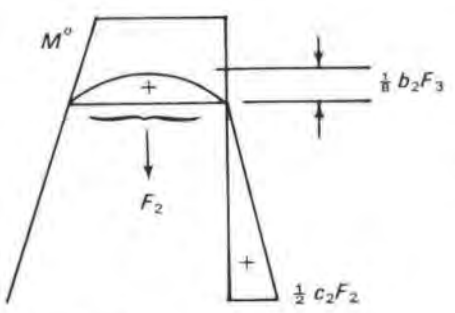

In terms of  $F_2$

| Factor: | Bending              |                                | Extension                                      |                               |  |
|---------|----------------------|--------------------------------|--|-------------------------------|--|
|         | $\frac{rb_2^2}{I_2}$ | $\frac{rh_2^2}{I_3}$           | $\frac{r}{A_2}$                                | $\frac{r}{A_3}$               | $\frac{r}{A_4}$                                |
| $U_1^o$ | $-\frac{1}{12}$      | .                              | .  | .                             | .  |
| $U_2^o$ | $-\frac{1}{24}$      | .                              | .  | .                             | .  |
| $U_3^o$ | .                    | .                              | $\frac{1}{2} \frac{c_2}{h_2} \frac{b_2}{h_1}$  | .                             | .  |
| $U_4^o$ | $\frac{1}{12}$       | $\frac{1}{2} \frac{c_2}{h_2}$  | .  | .                             | .  |
| $U_5^o$ | $\frac{1}{24} k_2$   | .                              | .  | $\frac{1}{2} \frac{h_2}{b_3}$ | $-\frac{1}{2} \frac{l_2}{b_3}$                 |
| $U_6^o$ | $\frac{1}{12}$       | $\frac{1}{12} \frac{c_2}{h_2}$ | $-\frac{1}{2} \frac{c_2}{h_2} \frac{b_2}{h_2}$ | .                             | $-\frac{1}{2} \frac{l_2}{h_2} \frac{c_2}{h_2}$ |

Let  $X = H_1 X^{[2]}$   
 whence  $U^{[2]} = H_1' U$

Thus  $H_1' G H_1 = G^{[2]}$  becomes

$$\begin{bmatrix} I & A'_{21} & . \\ . & I & . \\ . & A'_{23} & I \end{bmatrix} \begin{bmatrix} G_{11} & G_{12} & . \\ G_{21} & G_{22} & G_{23} \\ . & G_{32} & G_{33} \end{bmatrix} \begin{bmatrix} I & . & . \\ A_{21} & I & A_{23} \\ . & . & . \end{bmatrix} = \begin{bmatrix} G_{11}^{[2]} & . & G_{13}^{[2]} \\ . & G_{22} & . \\ G_{31}^{[2]} & . & G_{33}^{[2]} \end{bmatrix} \quad (58)$$

when  $A_{21} = -G_{22}^{-1} G_{21}$   
 $A_{23} = -G_{22}^{-1} G_{23}$

whence  $G_{11}^{[2]} = G_{11} + G_{12} A_{21}$  (still symmetric)

$G_{13}^{[2]} = G_{12} A_{23}$

$G_{33}^{[2]} = G_{33} + G_{32} A_{23}$  (still symmetric)

and  $G_{31}^{[2]} = G_{32} A_{21}$  is the transpose of  $G_{13}^{[2]}$

For this second stage set of equations,  $G^{[2]} X^{[2]} = U^{[2]}$

$$\begin{bmatrix} U_1^{[2]} \\ U_2^{[2]} \\ U_3^{[2]} \end{bmatrix} = \begin{bmatrix} I & A'_{21} & . \\ . & I & . \\ . & A'_{23} & I \end{bmatrix} \begin{bmatrix} U_1 \\ U_2 \\ U_3 \end{bmatrix} \quad (59)$$

i.e.  $U_1^{[2]} = U_1 + A'_{21} U_2$   
 $U_2^{[2]} = U_2$   
 $U_3^{[2]} = U_3 + A'_{23} U_2$

Since  $G_{22}$  is now isolated,

$X_2^{[2]} = G_{22}^{-1} U_2$  (60)

leaving

$$\begin{bmatrix} X_1^{[2]} \\ X_3^{[2]} \end{bmatrix} = \begin{bmatrix} G_{11}^{[2]} & G_{13}^{[2]} \\ G_{31}^{[2]} & G_{33}^{[2]} \end{bmatrix} \begin{bmatrix} U_1^{[2]} \\ U_3^{[2]} \end{bmatrix} \quad (61)$$

When the lower group has been dealt with in the same way for its different  $U$  subvectors, the isolation of the thus condensed equations proceeds with successive transformations of appropriate kinds. Then by back substitution, the second stage will be reached, again giving the  $X^{[2]}$  subvectors in Equation 61. The required first stage  $X$  set is then obtained from

$$\begin{bmatrix} X_1 \\ X_2 \\ X_3 \end{bmatrix} = \begin{bmatrix} I & . & . \\ A_{21} & I & A_{23} \\ . & . & I \end{bmatrix} \begin{bmatrix} X_1^{[2]} \\ X_2^{[2]} \\ X_3^{[2]} \end{bmatrix} \quad (62)$$

i.e.  $X_1 = X_1^{[2]}$   
 $X_2 = X_2^{[2]} + A_{21} X_1^{[2]} + A_{23} X_3^{[2]}$   
 $X_3 = X_3^{[2]}$

For this sort of work the reciprocal of  $G_{22}$  would be evaluated as a preliminary step.

**Table 6**  
Numerical counterpart of Table 5

$r = 10$

|         |          |         |          |         |          |               |
|---------|----------|---------|----------|---------|----------|---------------|
|         |          |         |          | Factor: | 171.76   | Total         |
|         |          |         |          | $U_1^o$ | -0.5     | - 85.88 $F_1$ |
|         |          |         |          | $U_2^o$ | .        | .             |
|         |          |         |          | $U_3^o$ | -0.16667 | - 28.63 $F_1$ |
|         |          |         |          | Factor: | 386.45   | .             |
|         |          |         |          | $U_4^o$ | -1.16667 | -450.86 $F_1$ |
|         |          |         |          | $U_5^o$ | .        | .             |
|         |          |         |          | $U_6^o$ | -0.5     | -193.22 $F_1$ |
| Factor: | 133.65   | 386.45  | 0.31     | 0.23    | 0.18     | Total         |
| $U_1^o$ | -0.08333 | .       | .        | .       | .        | - 11.14 $F_2$ |
| $U_2^o$ | -0.04167 | .       | .        | .       | .        | - 5.57 $F_2$  |
| $U_3^o$ | .        | .       | 0.07812  | .       | .        | 0.02 $F_2$    |
| $U_4^o$ | 0.08333  | 0.0625  | .        | .       | .        | 35.29 $F_2$   |
| $U_5^o$ | 0.02604  | .       | .        | 0.75    | -0.73308 | 3.52 $F_2$    |
| $U_6^o$ | 0.08333  | 0.02083 | -0.05208 | .       | -0.12885 | 19.15 $F_2$   |

When  $F_1 = 14$  tons and  $F_2 = 48$  tons

|                   |       |       |       |       |       |       |
|-------------------|-------|-------|-------|-------|-------|-------|
| $U = -U^o \equiv$ | $U_1$ | $U_2$ | $U_3$ | $U_4$ | $U_5$ | $U_6$ |
| =                 | 1737  | 267   | 400   | 4618  | -169  | 1786  |

**Table 7**  
Solution. Numerical counterpart of Table 1

|               |        |         |         |         |         |         |
|---------------|--------|---------|---------|---------|---------|---------|
|               | 1      | 2       | 3       | 4       | 5       | 6       |
| $g_1$         | 2.4619 | 0.9462  | 0.9690  | -0.8910 | -0.2784 | -0.8910 |
| $a_1$         | 0.4062 | -0.3843 | -0.3936 | 0.3619  | 0.1131  | 0.3619  |
| $g_2$         | .      | 0.6643  | 0.2894  | -0.4455 | -0.1856 | -0.4455 |
| $g_2^{[2]}$   | .      | 0.3007  | -0.0830 | -0.1031 | -0.0786 | -0.1031 |
| $a_2$         | .      | 3.3256  | 0.2760  | 0.3429  | 0.2614  | 0.3429  |
| $g_3$         | .      | .       | 0.7696  | .       | .       | -0.0005 |
| $g_3^{[3]}$   | .      | .       | 0.3653  | 0.3222  | 0.0879  | 0.3217  |
| $a_3$         | .      | .       | 2.7375  | -0.8820 | -0.2406 | -0.8807 |
| $g_4$         | .      | .       | .       | 2.6969  | 0.8735  | 1.7939  |
| $g_4^{[4]}$   | .      | .       | .       | 2.0549  | 0.6683  | 1.1524  |
| $a_4$         | .      | .       | .       | 0.4866  | -0.3252 | -0.5608 |
| $g_5$         | .      | .       | .       | .       | 0.6106  | 0.5533  |
| $g_5^{[5]}$   | .      | .       | .       | .       | 0.3201  | -0.0266 |
| $a_5$         | .      | .       | .       | .       | 3.1240  | 0.0831  |
| $g_6$         | .      | .       | .       | .       | .       | 1.4933  |
| $g_6^{[6]}$   | .      | .       | .       | .       | .       | 0.2037  |
| $e_6^{-1}$    | .      | .       | .       | .       | .       | 4.9092  |
| $U$           | 1737   | 267     | 400     | 4618    | - 169   | 1786    |
| $u$           | 1737   | - 401   | - 394   | 5457    | -1757   | - 582   |
| $x = E^{-1}u$ | 706    | -1334   | -1079   | 2655    | -5489   | -2857   |
| $X$           | 3187   | -2425   | -2582   | 6119    | -5726   | -2857   |
| Check         |        |         |         |         |         |         |
| $U = GX$      | 1737   | 267     | 401     | 4616    | - 169   | 1784    |

**Table 8**  
Stress resultants

| $\bar{x}^o$ |                |                                |       |                       |                       |       |                       |                       |
|-------------|----------------|--------------------------------|-------|-----------------------|-----------------------|-------|-----------------------|-----------------------|
| Factor:     | $F_1$          | $F_2$                          | $X_1$ | $X_2$                 | $X_3$                 | $X_4$ | $X_5$                 | $X_6$                 |
| Point       | Bending moment |                                |       |                       |                       |       |                       |                       |
| 1           | $-h_1$         | .                              | 1     | .                     | .                     | .     | .                     | .                     |
| 2           | .              | .                              | 1     | .                     | 1                     | .     | .                     | .                     |
| 3           | .              | .                              | 1     | $k_1$                 | 1                     | .     | .                     | .                     |
| 4           | .              | .                              | 1     | 1                     | .                     | .     | .                     | .                     |
| 5           | .              | .                              | -1    | .                     | .                     | 1     | .                     | 1                     |
| 6           | .              | $\frac{1}{8} b_2$              | -1    | $-\frac{1}{2}$        | .                     | 1     | $\frac{1}{2} k_2$     | 1                     |
| 7           | .              | .                              | -1    | -1                    | .                     | 1     | $k_2$                 | 1                     |
| 8           | $-h_1$         | .                              | .     | .                     | .                     | 1     | .                     | 1                     |
| 9           | $-(h_1+h_2)$   | $\frac{1}{2} c_2$              | .     | .                     | .                     | 1     | .                     | .                     |
| 10          | .              | .                              | .     | .                     | .                     | 1     | $k_2$                 | 1                     |
| 11          | .              | .                              | .     | .                     | .                     | 1     | 1                     | .                     |
| Member      | Tension        |                                |       |                       |                       |       |                       |                       |
| 1-2         | .              | .                              | .     | $-\frac{1}{b_2}$      | .                     | .     | .                     | .                     |
| 2-3         | .              | .                              | .     | .                     | $\frac{1}{h_1}$       | .     | .                     | .                     |
| 3-4         | .              | .                              | .     | $\frac{h_1}{b_2 l_1}$ | $\frac{c_1}{h_1 l_1}$ | .     | .                     | .                     |
| 5-7         | .              | $-\frac{1}{2} \frac{c_2}{h_2}$ | .     | .                     | $-\frac{1}{h_1}$      | .     | .                     | $\frac{1}{h_2}$       |
| 8-9         | .              | $-\frac{1}{2}$                 | .     | .                     | .                     | .     | $-\frac{1}{b_3}$      | .                     |
| 10-11       | .              | $-\frac{1}{2} \frac{l_2}{h_2}$ | .     | .                     | .                     | .     | $\frac{h_2}{b_2 l_2}$ | $\frac{c_2}{h_2 l_2}$ |
| Member      | Shear          |                                |       |                       |                       |       |                       |                       |
| 1-2         | 1              | .                              | .     | .                     | $\frac{1}{h_1}$       | .     | .                     | .                     |
| 2-3         | .              | .                              | .     | $\frac{1}{b_2}$       | .                     | .     | .                     | .                     |
| 3-4         | .              | .                              | .     | $\frac{c_1}{b_2 l_1}$ | $-\frac{1}{l_1}$      | .     | .                     | .                     |
| 5           | .              | $\frac{1}{2}$                  | .     | $-\frac{1}{b_2}$      | .                     | .     | $\frac{1}{b_3}$       | .                     |
| 6           | .              | .                              | .     | $-\frac{1}{b_2}$      | .                     | .     | $\frac{1}{b_3}$       | .                     |
| 7           | .              | $-\frac{1}{2}$                 | .     | $-\frac{1}{b_2}$      | .                     | .     | $\frac{1}{b_3}$       | .                     |
| 8-9         | 1              | $-\frac{1}{2} \frac{c_2}{h_2}$ | .     | .                     | .                     | .     | .                     | $\frac{1}{h_2}$       |
| 10-11       | .              | .                              | .     | .                     | .                     | .     | $\frac{c_2}{h_2 l_2}$ | $-\frac{1}{l_2}$      |

**Table 9**  
Numerical counterpart of Table 8

|        | $\bar{x}^o$                  | $X = 3187$ | -2425    | -2582    | 6119 | -5726    | -2857    | Total<br>$\bar{x} = \bar{x}^o + AX$ |
|--------|------------------------------|------------|----------|----------|------|----------|----------|-------------------------------------|
| Point  | Bending moment : tons inches |            |          |          |      |          |          |                                     |
| 1      | -3360                        | 1          | .        | .        | .    | .        | .        | - 173                               |
| 2      | .                            | 1          | .        | 1        | .    | .        | .        | 605                                 |
| 3      | .                            | 1          | 0.6      | 1        | .    | .        | .        | - 850                               |
| 4      | .                            | 1          | 1        | .        | .    | .        | .        | 762                                 |
| 5      | .                            | -1         | .        | .        | 1    | .        | 1        | 75                                  |
| 6      | 900                          | -1         | -0.5     | .        | 1    | 0.3125   | 1        | 398                                 |
| 7      | .                            | -1         | -1       | .        | 1    | 0.625    | 1        | -1079                               |
| 8      | -3360                        | .          | .        | .        | 1    | .        | 1        | - 98                                |
| 9      | -6240                        | .          | .        | .        | 1    | .        | .        | - 121                               |
| 10     | .                            | .          | .        | .        | 1    | 0.625    | 1        | - 317                               |
| 11     | .                            | .          | .        | .        | 1    | 1        | .        | 393                                 |
| Member | Tension : Tons               |            |          |          |      |          |          |                                     |
| 1-2    | .                            | .          | -0.00667 | .        | .    | .        | .        | 16.2                                |
| 2-3    | .                            | .          | .        | 0.00417  | .    | .        | .        | -10.8                               |
| 3-4    | .                            | .          | 0.00647  | 0.00101  | .    | .        | .        | -18.3                               |
| 5-7    | - 6                          | .          | .        | -0.00417 | .    | .        | 0.00278  | - 3.2                               |
| 8-9    | - 24                         | .          | .        | .        | .    | -0.00417 | .        | - 0.1                               |
| 10-11  | -247                         | .          | .        | .        | .    | 0.00404  | 0.00067  | -49.7                               |
| Member | Shear : Tons                 |            |          |          |      |          |          |                                     |
| 1-2    | 14                           | .          | .        | 0.00417  | .    | .        | .        | 3.2                                 |
| 2-3    | .                            | .          | 0.00667  | .        | .    | .        | .        | -16.2                               |
| 3-4    | .                            | .          | 0.00162  | -0.00404 | .    | .        | .        | 6.5                                 |
| 5      | 24                           | .          | -0.00667 | .        | .    | 0.00417  | .        | 16.3                                |
| 6      | .                            | .          | -0.00667 | .        | .    | 0.00417  | .        | - 7.7                               |
| 7      | -24                          | .          | -0.00667 | .        | .    | 0.00417  | .        | -31.7                               |
| 8-9    | 8                            | .          | .        | .        | .    | .        | 0.00278  | 0.1                                 |
| 10-11  | .                            | .          | .        | .        | .    | 0.00101  | -0.00270 | 1.9                                 |

In conclusion, a language has now been defined which makes possible the discussion of a great variety of structural forms with point and brevity, for example, open web girders, diagrids, secondary stresses in Warren girders, and three-dimensional frames. The theorem stated on page 18 is so useful in the design of continuous prestressed concrete structures that the point merits a brief mention. After the stresses due to the loads have been found by selecting suitable primary systems; those due to prestress alone may be obtained, without changing the redundant system, by the use of a primary system which assumes all the boundary supports are removed, for this is clearly an equilibrium state.

#### References

- (1) AITKEN, A. C. Determinants and matrices. Oliver and Boyd, 1939 and later editions.
- (2) OSTENFELD, A. Teknisk Statik. Jul. Gjellerups Boghandel, Copenhagen, 1913.
- (3) JENKINS, R. S. Theory and design of cylindrical shell structures. Ove Arup & Partners, 1947.
- (4) FOX, L. Practical methods for the solution of linear simultaneous equations and the inversion of matrices. *Royal Statistical Society Journal (Series B)*, 12, pp. 120-136, 1950.

The second path lay in the field of the analysis of doubly curved shells and of thick curved bodies. It was always clear to Ronald Jenkins that to treat these properly it was necessary to work in curvilinear co-ordinate systems chosen so that the boundaries of the structure were formed by co-ordinate lines. But the use of curvilinear co-ordinates required transformations from one system to another. One language to handle such transformations is that of matrix algebra.

Starting with the practical task of designing the doubly-curved translational domes of Brynmawr this approach led him to the general formulation of the membrane theory of thin shells presented at the symposium on Concrete Shell Roof Construction in London in 1952. This paper, Theory of new forms of shell, was yet another landmark. Although of considerable historical and practical interest and typifying his economy and precision of thought it is not reprinted here because much of the material appears in the final two papers that have been printed.

The practical relevance of this paper, even today, is that, given a shell with a mathematically defined surface and therefore a transformation matrix between cartesian and curvilinear co-ordinates, the engineer can derive the properties of the shell at any point. This can be done by analytical processes without recourse to difficult and dangerous geometric visualization. These shell properties include purely geometric ones (such as the direction of the normal to the surface) but also the coefficients of the simultaneous differential equations of equilibrium for the membrane forces. The method of solution given in the paper to solve these equations was to introduce a stress-function to reduce them to a single differential equation (with, of course, coefficients varying over the shell). This equation was then to be converted to a set of finite difference equations on a mesh of curvilinear coordinates and solved by relaxation. Nowadays, of course, the finite difference equation would be solved directly. The above theory was also explained in the Taylor Woodrow Foundation Lectures (1961) where it was developed in greater detail for shallow shells, for general cylindrical shells and, of special interest, for hyperbolic paraboloids.

With computers came the possibility of extending the theory to deal with curved bodies or the bending theory of doubly curved shells. He showed how this might be done in a paper presented at the 50th Anniversary Conference of the Institution of Structural Engineers, 1958, entitled 'Towards a variational method for the static equilibrium of curved bodies and shells' and reproduced here. The basic method proposed was to express at each mesh point the condition that the total potential energy of the structure was a minimum. This condition, expressed in terms of matrix operations on the original transformation to the curvilinear co-ordinates, led to three finite difference equations at each mesh point to be solved for the three displacements from which membrane forces and bending moments can be deduced. He foresaw no difficulty in principle in including the potential energy of

the boundary members or of treating ridged shells made up of different surfaces with abrupt changes of slope. It can be seen that the change from the treatment for thick curved bodies to that for thin shells, although giving a sharp reduction in the number of mesh points and storage capacity required, does so at the expense of greater complication in the exposition and manipulation. This paper was in advance of its time because, as he realized, computers with the necessary storage capacity were not then available. By the time they were, other methods such as finite element or dynamic relaxation had been developed and were preferred. However, apparently, difficulties have been experienced in using finite elements for general doubly-curved shells and this may suggest that it is worthwhile to re-examine the question of solution methods.

It steadily became apparent to Ronald Jenkins that matrices were in some respects of limited power for dealing with curved bodies and shells. This was apparent in some particular results whose derivation by matrix methods needed a mental agility which few of his readers possessed. He therefore began to study the ideas of tensor analysis, which after all, was devised to investigate the effects of changes of co-ordinate system. The first result of this interest was Comparison of two- and three-dimensional analysis of arch dams by matrix-tensor methods presented at the International Symposium on the Theory of Arch Dams, in Southampton in 1964. This essentially followed the treatment of his earlier papers but introduced in a fairly limited way tensor notation and ideas where they seemed useful. He also took the development further to suit the proposed method of numerical solution, that of matrix progression (reference The solution of shell problems by the matrix progression method, H. Tottenham and R. S. Jenkins, 1962) and examined, in principle, the approximations involved in treating a thick shell as a two-dimensional problem.

Tensor concepts are taken slightly further in the last paper printed here. This is an unpublished report prepared to describe the proposed analysis of a particular dome roof in the shape of a deformed elliptic paraboloid. Again the treatment was essentially that of Theory of new forms of shell and limited to membrane forces. The development was directed towards a solution through the integral equation derived from overall equilibrium of the shell and was widened to include quantities such as principal stresses and curvatures.

These last two papers represented only intermediate steps in the progression of Ronald Jenkins' thinking. This had led him to write a substantial unpublished work which he was still in the process of improving at the time of his death. In this he made a much more thoroughgoing use of tensors in the analysis of shells, giving, for example, much attention to tensor derivatives and no doubt finding novel applications for these concepts. The significance, theoretical and practical, of this work has still to be assessed.

John Blanchard

## Towards a variational method for the static equilibrium of curved bodies and shells

### Introduction

On the design side of structural engineering, the electronic digital computer offers the fascinating prospect of being able to deal with problems intractable other than by numerical methods. Among these problems are stress analysis in complex shapes, their safety and stability, and the real physical properties of materials.

In approaching the design of curved bodies, such as arch dams, and shells of other than simple shapes, their static equilibrium under small displacements must be considered before it is possible to go into questions such as elastic or elasto-plastic stability. With electronic machines in mind, the author introduced a matrix form of elasticity in curvilinear co-ordinates in the Symposium on Concrete Shell Roof Construction,<sup>1</sup> 1952. The matrix notation, which displays the structure of the analysis, is eminently suitable to the purpose of this paper, of developing the theory to the point where the sorting and numerical operations can be visualized.

In the earlier publication referred to, it was pointed out that the proposed solution of static equilibrium is a simple concept.

A grid of points in the body is established by taking small finite intervals ( $\delta\alpha \delta\beta \delta\gamma$ ) in the three families of surfaces ( $\alpha \beta \gamma$ ). Preferably, the system of curvilinear co-ordinates should be such that the boundaries, so far as possible, occupy  $\alpha = \text{constant}$ ,  $\beta = \text{constant}$  and  $\gamma = \text{constant}$ . The body is thus divided up into small volumes,  $\sqrt{g} \delta\alpha \delta\beta \delta\gamma$ , centred at each internal grid point; half this value at a boundary grid point, and a quarter at an edge point.

When the body becomes strained the surfaces ( $\alpha \beta \gamma$ ) at a grid point

move to new positions ( $\alpha+u, \beta+v, \gamma+w$ ), where  $u \equiv \{u \ v \ w\}$  are the curvilinear displacements, assumed to be very small. The potential energy integral,  $F$ , is defined in terms of these displacements and their derivatives. The solution is obtained by minimizing the potential energy by

$$\frac{\partial F}{\partial u_i} = 0, \quad \frac{\partial F}{\partial v_j} = 0, \quad \frac{\partial F}{\partial w_k} = 0$$

where the subscript  $i$  is meant to cover each grid point in turn over the whole body.

When the derivatives of displacements are expressed as finite differences, the minimizing process gives a set of simultaneous equations in  $u_i, v_j$  and  $w_k$ , numbering three times the number of grid points. The volume integrals represented by  $\partial F / \partial u_i$ , etc, will each only be concerned with a small region: the grid point under consideration and its neighbours. In curvilinear co-ordinates the coefficients of these equations will vary from point to point, so that electronic machines offer the only practical means of finding the coefficients and solving the equations. It is clear that the type of machine required is one capable of handling this generalized Relaxation, and this may still lie in the future.

The particulars of matrix usage to be adopted were explained in the earlier publication but there are two points on which it would be well to be more expansive.

The first is that the convention of placing the vector operator,  $\nabla$ , before the operand was discarded as too hampering for matrix analysis. Thus, using round brackets to indicate an operand, the following operation on a matrix product, resulting in a column vector, may be expanded by the rules of partial differentiation:

$$(AB)\nabla = (A)B\nabla + A(B)\nabla$$

Secondly there are some consequences of the scalar (dot) product of two matrices of the same order. When the component of a matrix,  $A$ , in the  $i$ th row and  $k$ th column is denoted by  $a_{ik}$ , all matrix analysis may be alternatively expressed by means of the summation

convention. The latter is the sum obtained by making each *repeated* subscript take all possible values.

Thus  $A \cdot B = a_{ik} b_{jk} = B \cdot A = A' \cdot B'$

The scalar product of matrix products may be re-arranged as follows:

$$CAD \cdot B = c_{ih} a_{hj} d_{jk} b_{ik} = a_{hj} c_{ih} b_{ik} d_{jk} = A \cdot C' B D'$$

When  $B$  is the outer product of two vectors,  $bc'$ :

$$A \cdot bc' = a_{ik} b_j c_k = b_j a_{ik} c_k = b' A c$$

The last is called a bilinear form.

This identity of a scalar product with a bilinear form will be used with the vector operator, e.g.:

$$P \cdot (u) \nabla' = (u') P \nabla \\ \text{or } P \cdot \nabla (u') = \nabla' P (u) = (u') P' \nabla$$

These two are equal when  $P$  is symmetric.

The four pages in the publication referred to dealt with elasticity in three-dimensional curvilinear co-ordinates, but the reduction to two dimensions for the middle surface of a shell was only hinted at. The latter is the main present purpose but strangely enough the explanation of the proposed method is so much easier in three dimensions that this development will be taken first.

### Potential energy and its minimization in a curved solid body

It is appropriate to think of a double curved arch dam and how convenient it would be if the upstream face lay on  $\alpha = \text{one constant}$ , and the downstream face on  $\alpha = \text{another constant}$ .

The total strain energy is the volume integral:

$$U = \frac{1}{2} \int \int \int P \cdot V \sqrt{g} \, da \, d\beta \, d\gamma \quad (1)$$

where  $P$  is the stress matrix and  $V$  the strain matrix, exactly as already defined.

From the strain in terms of displacements:

$$V = A^{-1} W A^{-1}$$

where

$$2W = J'(Ju) \nabla' + \nabla (u' J') J = G(u) \nabla' + \nabla (u') G + u' \nabla (G)$$

and the transformation of a scalar matrix product into a bilinear form:

$$U = \frac{1}{2} \int \int \int (u' J') J A^{-1} P A^{-1} \nabla \sqrt{g} \, da \, d\beta \, d\gamma \quad (2)$$

the proof in curvilinear co-ordinates of the Theorem of Minimum Potential Energy illustrates the power of matrix methods.

Consider the identity:

$$\frac{1}{2} \int \int \int (u' J' J A^{-1} P A^{-1} \nabla \sqrt{g}) \nabla \, da \, d\beta \, d\gamma = \\ \frac{1}{2} \int \int \int (u' J' J A^{-1} P A^{-1} \nabla \sqrt{g}) \, da \, d\beta \, d\gamma + \\ \frac{1}{2} \int \int \int u' J' (J A^{-1} P A^{-1} \nabla \sqrt{g}) \nabla \, da \, d\beta \, d\gamma \quad (3)$$

The first expression, by Green's Theorem or writing it out in full, is the surface integral of the work done by applied surface stresses, and may be put

$$\frac{1}{2} \int \int u' \nabla G A^{-1} T_v ds = \frac{1}{2} \int \int u' \nabla A E T_v ds \quad (4)$$

where

$$\text{on face } \alpha = \text{constant}, T_v = \{T_{\alpha\alpha} \, T_{\beta\alpha} \, T_{\gamma\alpha}\} \text{ and } ds = \frac{\sqrt{g}}{a} \, d\beta \, d\gamma$$

$$\text{.. .. } \beta = \text{constant}, T_v = \{T_{\alpha\beta} \, T_{\beta\beta} \, T_{\gamma\beta}\} \text{ and } ds = \frac{\sqrt{g}}{b} \, da \, d\gamma$$

$$\text{.. .. } \gamma = \text{constant}, T_v = \{T_{\alpha\gamma} \, T_{\beta\gamma} \, T_{\gamma\gamma}\} \text{ and } ds = \frac{\sqrt{g}}{c} \, da \, d\beta$$

There are several points of interest here.

$T_v$  are the surface pressures per unit area of the appropriate right cross section of the element.

The expressions for  $ds$  are these areas from  $(\beta\gamma)$  to  $(\beta + d\beta \, \gamma + d\gamma)$ , etc.  $u'$  are curvilinear displacements, so that  $u' A$  are the actual displacements.

$u' A E$  gives the actual displacement in the direction of each force.

The second term in Equation 3 is the strain energy.

By substituting the equations of equilibrium,

$$(J A^{-1} P A^{-1} \nabla \sqrt{g}) \nabla + J A^{-1} \nabla \sqrt{g} X = 0$$

in the third term, it becomes

$$-\frac{1}{2} \int \int u' \nabla G A^{-1} X d\tau = -\frac{1}{2} \int \int u' A E X d\tau$$

Thus the identity leads to the truism that strain energy is equal to the work done by the surface loads and the body forces:

$$U = \frac{1}{2} \int \int u' \nabla G A^{-1} T_v ds + \frac{1}{2} \int \int u' \nabla G A^{-1} X d\tau \quad (5)$$

The stress-strain relation in three dimensional curvilinear co-ordinates was given:

$$P = \frac{E}{1+\sigma} \left\{ E^{-1} V E^{-1} + \frac{\sigma}{1-2\sigma} \Delta E^{-1} \right\}$$

where the dilatation

$$\Delta = V \cdot E^{-1} = W \cdot G^{-1} = (u') \nabla + \frac{1}{2} u' \nabla (G) \cdot G^{-1}$$

By substituting this in the strain energy Equation 1, the strain energy

in terms of displacements becomes:

$$U = \frac{1}{2} \int \int \frac{E}{1+\sigma} \left\{ G^{-1} W \cdot W G^{-1} + \frac{\sigma}{1-2\sigma} \Delta \Delta \right\} d\tau \quad (6)$$

The variational argument is as follows:

Let the equilibrium displacements,  $u \equiv \{u \, v \, w\}$  be varied by an arbitrary\*  $\delta u \equiv \{\delta u \, \delta v \, \delta w\}$ , causing total stresses of  $P + \delta P$ .

It is evident from Equation 6 that  $P \cdot \delta V = V \cdot \delta P$ .

The corresponding strain energy is changed to

$$U + \delta U = \frac{1}{2} \int \int (u' + \delta u' J') J A^{-1} P + \delta P A^{-1} \nabla d\tau \\ = U + \int \int (\delta u' J') J A^{-1} P A^{-1} \nabla d\tau + \frac{1}{2} \int \int (\delta u' J') J A^{-1} \delta P A^{-1} \nabla d\tau$$

The  $\frac{1}{2}$  is omitted from the second term because it comprises two equal terms arising from  $P \cdot \delta V = V \cdot \delta P$ . Therefore the positive integral of the last term:

$$\frac{1}{2} \int \int (\delta u' J') J A^{-1} \delta P A^{-1} \nabla d\tau = \delta U - \int \int (\delta u' J') J A^{-1} P A^{-1} \nabla d\tau \\ = \delta U - \delta \int \int u' \nabla G A^{-1} T_v ds - \delta \int \int u' \nabla G A^{-1} X d\tau$$

where  $X$  are known, and  $T_v$  are known on that part of the boundary surface where the corresponding displacements are unknown.

The equilibrium displacements therefore satisfy

$$\delta \left\{ U - \int \int u' \nabla G A^{-1} T_v ds - \int \int u' \nabla G A^{-1} X d\tau \right\} = 0$$

and the solution is obtained by minimizing the potential energy integral:

$$F = U - \int \int u' \nabla G A^{-1} T_v ds - \int \int u' \nabla G A^{-1} X d\tau \quad (7)$$

In the method, already outlined, of using the displacements themselves as the parameters of the Rayleigh-Ritz process, take as an example,

$$\frac{\partial F}{\partial w_0} = 0$$

where the subscript  $0$  denotes the point under consideration and the subscript  $k$  denotes any grid point.

The machine has determined numerically and stored the matrices,  $G$ ,  $G^{-1}$ ,  $A$ ,  $\partial G / \partial \alpha$ ,  $\partial G / \partial \beta$ ,  $\partial G / \partial \gamma$  and the scalar  $\sqrt{g}$  at each grid point. Let the symmetric matrix  $G_k$  be denoted by

$$G_k \equiv \begin{bmatrix} g_{\alpha\alpha} & g_{\alpha\beta} & g_{\alpha\gamma} \\ g_{\alpha\beta} & g_{\beta\beta} & g_{\beta\gamma} \\ g_{\alpha\gamma} & g_{\beta\gamma} & g_{\gamma\gamma} \end{bmatrix}$$

The third term in  $F$ , the change of potential of body forces on the volume element at point 0, gives

$$-\frac{\partial}{\partial w_0} \int \int u' \nabla G A^{-1} X \sqrt{g} \, da \, d\beta \, d\gamma = - \left[ \begin{array}{ccc} & & 1 \end{array} \right] G A^{-1} X \sqrt{g} \, \delta \alpha \, \delta \beta \, \delta \gamma \\ = - \left( \frac{g_{\alpha\gamma}}{a} X + \frac{g_{\beta\gamma}}{b} Y + \frac{g_{\gamma\gamma}}{c} Z \right) \sqrt{g} \, \delta \alpha \, \delta \beta \, \delta \gamma \quad (8)$$

all the coefficients being at point 0.

The first term in  $F$ , the strain energy, gives

$$\frac{\partial U}{\partial w_0} = \int \int \frac{E}{1+\sigma} \left\{ \frac{\partial W}{\partial w_0} \cdot G^{-1} W G^{-1} + \frac{\sigma}{1-2\sigma} \frac{\partial \Delta}{\partial w_0} \Delta \right\} d\tau$$

where

$$2W = G(u) \nabla' + \nabla (u') G + \left( u \frac{\partial}{\partial \alpha} + v \frac{\partial}{\partial \beta} + w \frac{\partial}{\partial \gamma} \right) (G)$$

$$\therefore \frac{\partial W}{\partial w_0} = \frac{1}{2} \frac{\partial}{\partial w_0} \begin{bmatrix} g_{\alpha\gamma} \\ g_{\beta\gamma} \\ g_{\gamma\gamma} \end{bmatrix} \begin{bmatrix} \frac{\partial w}{\partial \alpha} & \frac{\partial w}{\partial \beta} & \frac{\partial w}{\partial \gamma} \end{bmatrix} \\ + \text{transpose} + \frac{1}{2} \frac{\partial G}{\partial \gamma}$$

A typical term in  $\partial U / \partial w_0$ , when the coefficients have been multiplied out to  $\lambda_k$  is:

$$\sum_k \lambda_k \frac{\partial}{\partial w_0} \left( \frac{\partial w_k}{\partial \alpha} \right) \frac{\partial u_k}{\partial \beta} \, \delta \alpha \, \delta \beta \, \delta \gamma$$

These are products in the  $\gamma$  surface through grid point 0, and the value in finite differences may be tabulated from the following

\*The variations of displacements are arbitrary with the usual qualifications. They are continuous functions over the body and become zero at the boundary where the corresponding boundary displacements are known.

diagram in which the neighbouring grid points have been numbered in the manner familiar to Relaxationists:

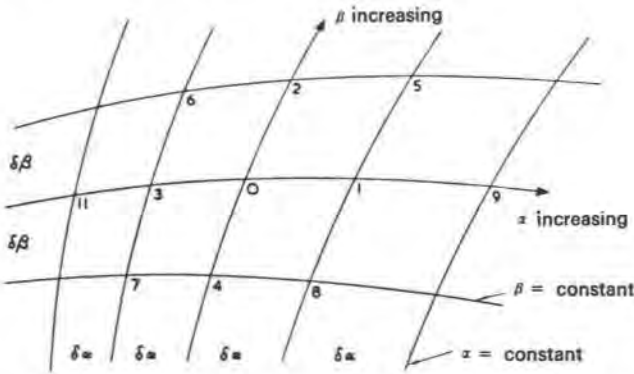

| Coefficient   | $\lambda_3$                          | $\lambda_0$                       | $\lambda_1$                       |
|---|--------------------------------------|-----------------------------------|-----------------------------------|
| $\frac{\partial w_k}{\partial \alpha}$ involving $w_0$                              | $\frac{w_0 - w_{11}}{2\delta\alpha}$ | $\frac{w_1 - w_3}{2\delta\alpha}$ | $\frac{w_9 - w_0}{2\delta\alpha}$ |
| $\frac{\partial}{\partial w_0} \left( \frac{\partial w_k}{\partial \alpha} \right)$ | $\frac{1}{2\delta\alpha}$            |                                   | $-\frac{1}{2\delta\alpha}$        |
| $\frac{\partial u_k}{\partial \beta}$   | $\frac{u_6 - u_7}{2\delta\beta}$     |                                   | $\frac{u_5 - u_8}{2\delta\beta}$  |

Thus the term quoted above is equal to

$$\frac{\delta\gamma}{4} \left\{ \lambda_3 (u_6 - u_7) - \lambda_1 (u_5 - u_8) \right\} \quad (9)$$

For a repeated term such

$$\sum_k \lambda_k \frac{\partial}{\partial w_0} \left( \frac{\partial w_k}{\partial \alpha} \right) \frac{\partial w_k}{\partial \alpha} \delta\alpha \delta\beta \delta\gamma$$

the compactness of Relaxation may be retained by specifying the coefficients as the mean between adjacent points, denoted by  $\lambda_{03}$  and  $\lambda_{01}$  so far as this term is concerned. The tabulation then becomes:

| Coefficient   | $\lambda_{03}$                   | $\lambda_{01}$                   |
|---|----------------------------------|----------------------------------|
| $\frac{\partial w_k}{\partial \alpha}$ involving $w_0$                              | $\frac{w_0 - w_3}{\delta\alpha}$ | $\frac{w_1 - w_0}{\delta\alpha}$ |
| $\frac{\partial}{\partial w_0} \left( \frac{\partial w_k}{\partial \alpha} \right)$ | $1/\delta\alpha$                 | $-1/\delta\alpha$                |

Thus the term quoted above is equal to

$$\frac{\delta\beta \delta\gamma}{\delta\alpha} \left\{ \lambda_{03} (w_0 - w_3) - \lambda_{01} (w_1 - w_0) \right\} \quad (10)$$

At the boundaries, appropriate finite difference expressions will be applied and the boundary loads will be dealt with in the same way as shown for body forces.

The machine has to act as a kind of sorting office in proceeding from the coefficients to the finite difference equations represented by  $\partial F / \partial u_k = 0$ . The equations are of the harmonic type. When they have been solved, the coefficients will be used again in arriving at the strains and then the stresses from the stress-strain relation. The coefficients, of course, are functions of  $(\alpha, \beta, \gamma)$ , independent of the cartesian axes.

### Application to shells

The extra complication of the shell exposition arises from the desire to reduce the range and storage capacity of human or electronic calculators by using a two-dimensional grid on the middle surface. The three-dimensional treatment should be of interest to those who question the validity of what are called the *shell assumptions* and Kirchoff's boundary hypothesis.

In dealing with shells, the boundaries are the true boundaries of the structure. Thus if a shell edge is stiffened by a monolithic arch or length beam of small lateral dimensions compared with length, account is taken of its strain energy which may readily be expressed in terms of the shell edge displacements. If an edge is stiffened by a wall or wall-like beam, its potential energy may be brought into the account

by a grid treatment on its middle surface similar to that to be described for shells, if warranted. This idea may, indeed, be pursued into the supporting members and even the ground under the foundations – an investigation that might actually be carried out if it were desired to test the effect of differential settlements.

Thus shell surfaces with an abrupt change of slope, aptly called *ridged shells*, present no essential difficulty. It will be a great convenience if the ridge lies along a co-ordinate line,  $\alpha = \text{constant}$  or  $\beta = \text{constant}$ , common to the middle surface on both sides of the ridge. The same remark applies to shell boundaries and shows what to aim at in devising the curvilinear co-ordinate system.

Beginning with the three-dimensional, the two families  $(\alpha\beta)$  of lines on the middle surface are considered to lie in two families of surfaces normal to the mid-surface. The  $\gamma$  surfaces are parallel to the middle surface and  $\gamma = \text{constant}$  is defined as the surface at distance  $\gamma$  from the middle surface.

$x \equiv \{x y z\}$  are any convenient cartesian co-ordinates of a point on the middle surface. The cartesian co-ordinates of a point at  $\gamma$  from the middle surface are  $\{x + \gamma l, y + \gamma m, z + \gamma n\}$  where  $l \equiv \{l m n\}$  are the direction cosines of the normal.

In the earlier publication it was shown that at a point  $(\alpha\beta\gamma)$ ,

$$J = \begin{vmatrix} \frac{\partial}{\partial \alpha}(x + \gamma l) & \frac{\partial}{\partial \beta}(x + \gamma l) & l \\ \frac{\partial}{\partial \alpha}(y + \gamma m) & \frac{\partial}{\partial \beta}(y + \gamma m) & m \\ \frac{\partial}{\partial \alpha}(z + \gamma n) & \frac{\partial}{\partial \beta}(z + \gamma n) & n \end{vmatrix} = J_1 + \gamma J_2$$

where the subscript 1 denotes, throughout, the property of the middle surface.

In the triad provided by the intersections of the three surfaces  $(\alpha\beta\gamma)$  at a point, the axis in the direction of  $\gamma$  increasing is normal to the other two. Therefore the last row of the matrix  $J^{-1}$  is  $[l m n]$ . According to the context in what follows, the matrices  $J$  and  $J^{-1}$  are either the full  $3 \times 3$  matrices or else contracted matrices by suppressing the  $(l m n)$  last row or column. The same applies to the matrix of direction cosines of the triad,  $M$ , and its reciprocal  $M^{-1}$ .

Similarly the metric

$$G = G_1 + 2\gamma G_2 + \gamma^2 G_3$$

is either of order  $3 \times 3$  or else of order  $2 \times 2$  by suppressing the last unit of the leading diagonal in  $G_1$ .

When reciprocals or roots, with  $\gamma$  as an independent variable, cannot be found explicitly, recourse will be made to the binomial theorem\*, to an accuracy of  $\gamma^2$ .

Thus

$$G = G_1 (1 + 2\gamma G_1^{-1} G_2 + \gamma^2 G_1^{-1} G_3)$$

gives

$$G^{-1} = G_1^{-1} - 2\gamma G_1^{-1} G_2 G_1^{-1} + 3\gamma^2 G_1^{-1} G_3 G_1^{-1}$$

since

$$G_2 G_1^{-1} G_2 = G_3.$$

$$\sqrt{g} = |J| = \sqrt{g_1} \left( 1 + \gamma G_1^{-1} \cdot G_2 + \gamma^2 \frac{g_2}{g_1} \right) \text{ exactly,}$$

where

$$g_2 = |G_2| \text{ of order } 2 \times 2.$$

This implies that, in integrating over the shell thickness, the coefficients obtained will be:

$$\int_{-h}^h dy = 2h \quad \dots \text{ shell thickness, } t = 2h$$

$$\int_{-h}^h y dy = 0$$

$$\int_{-h}^h y^2 dy = \frac{2h^3}{3} \quad \dots \text{ second moment over thickness, } \frac{t^3}{12}$$

The expression of displacements  $(u v w)$  at a point,  $\gamma$ , in terms of displacements of the middle surface  $(u_1 v_1 w_1)$ , is carried out by applying the shell assumptions, which are:

(1) The normal displacement,  $w$ , is the same at all points on the normal, i.e.  $w$  is independent of  $\gamma$ .

(2) Lines normal to the middle surface stay normal to the strained middle surface, i.e. the normal shear strain components  $V_{\alpha\gamma}$  and  $V_{\beta\gamma}$  are zero.

\* See footnote on page 33.



The elimination of these shear strains from

$$2W = G(u)\nabla' + \nabla(u')G + u'\nabla(G),$$

gives

$$G \begin{bmatrix} \frac{\partial u}{\partial y} \\ \frac{\partial v}{\partial y} \end{bmatrix} + \begin{bmatrix} \frac{\partial w}{\partial \alpha} \\ \frac{\partial w}{\partial \beta} \end{bmatrix} = 0$$

whence

$$\begin{bmatrix} u \\ v \end{bmatrix} = \begin{bmatrix} u_1 \\ v_1 \end{bmatrix} - \int_0^y G^{-1} dy \begin{bmatrix} \frac{\partial w}{\partial \alpha} \\ \frac{\partial w}{\partial \beta} \end{bmatrix}$$

so that, retaining terms up to  $\gamma^2$

$$\begin{bmatrix} u \\ v \end{bmatrix} = \begin{bmatrix} u_1 \\ v_1 \end{bmatrix} - (\gamma G_1^{-1} - \gamma^2 G_1^{-1} G_2 G_1^{-1}) \begin{bmatrix} \frac{\partial w}{\partial \alpha} \\ \frac{\partial w}{\partial \beta} \end{bmatrix}$$

When  $H \equiv \gamma G_1^{-1} - \gamma^2 G_1^{-1} G_2 G_1^{-1}$ ;  
and  $u \equiv \{u v\}$ ;  $u_1 \equiv \{u_1 v_1\}$ ;

the equation may be written:

$$u = u_1 - H\nabla(w) \quad (11)$$

When it is noted that a part of the strain expression is:

$$(u)\nabla' = (u_1)\nabla' - (H) \begin{bmatrix} \frac{\partial w}{\partial \alpha} \\ \frac{\partial w}{\partial \beta} \end{bmatrix} \nabla' - H \begin{bmatrix} \frac{\partial^2 w}{\partial \alpha^2} & \frac{\partial^2 w}{\partial \alpha \partial \beta} \\ \frac{\partial^2 w}{\partial \alpha \partial \beta} & \frac{\partial^2 w}{\partial \beta^2} \end{bmatrix}$$

where  $\nabla \equiv \left\{ \frac{\partial}{\partial \alpha} \frac{\partial}{\partial \beta} \right\}$ , it is evident that in the finite difference

simultaneous equations,  $u_1$  and  $v_1$  will be of the harmonic class and  $w$  will be of the bi-harmonic class.

Expressions for stress resultants and stress couples are not required for the minimizing of potential energy, for in the volume integral,

$$\frac{\partial U}{\partial u_{1i}} = \int_V \frac{E}{1+\sigma} \left\{ \frac{\partial W}{\partial u_{1i}} \cdot G^{-1} W G^{-1} + \frac{\sigma}{1-\sigma} \frac{\partial \Delta}{\partial u_{1i}} \Delta \right\} \sqrt{g} da db dy$$

(where  $u_1$  is  $u_1, v_1$  or  $w$ )

which is now in the form for plane stress, when all the matrices and scalars have been reduced to the middle surface by the substitutions already given, the first operation\* will be the sorting into terms with  $\gamma$  coefficients of 1,  $\gamma$  and  $\gamma^2$ . When integrated over the shell thickness these coefficients will become  $t, \sigma, t^3/12$  respectively, where  $t$  is the shell thickness. When this has been done the integral becomes a surface integral over the middle surface.

With regard to the change in load potential it will usually be sufficient that the two tangential forces and normal force in the directions of the triad,  $X \equiv \{X Y Z\}$  are assumed to be applied to the middle surface. That part of the potential energy expression then becomes:

$$\frac{\partial F}{\partial u_{1i}} = -[1 \quad \dots] G_1 A_1^{-1} X \sqrt{g_1} \delta \alpha \delta \beta, \text{ etc.}$$

with coefficients for grid point  $i$ .

It would seem to be legitimate that a shell of varying thickness could be dealt with in the manner described, because the fact that the normal to middle surface would not be quite normal to the outer surfaces would be a matter of small consequence.

To conclude this part of the paper it is mentioned that the strain expression for shells is

$$2W = G(u)\nabla' + \nabla(u')G + u \frac{\partial G}{\partial \alpha} + v \frac{\partial G}{\partial \beta} + 2w(G_2 + \gamma G_3) \quad (12)$$

where

$$(u) \equiv \{u v\} \text{ and } \nabla \equiv \left\{ \frac{\partial}{\partial \alpha} \frac{\partial}{\partial \beta} \right\}$$

$G$  and  $u$  have to be replaced by the expansions in  $\gamma$  shown above.

The last part of the paper will consider stress resultants, stress couples and equations of equilibrium in these terms. This is required to find the normal shear stress resultants which are assumed not to contribute to strain energy, as well as for design purposes.

### Stress resultants, stress couples and equations of equilibrium in shells

In the preceding section, by nullifying the normal shear strains, all displacements were referred to the displacements of the middle surface,  $(u_1 v_1 w)$ , from

$$\begin{bmatrix} u \\ v \end{bmatrix} = \begin{bmatrix} u_1 \\ v_1 \end{bmatrix} - [\gamma G_1^{-1} - \gamma^2 G_1^{-1} G_2 G_1^{-1}] \nabla(w) \quad (13)$$

This strain matrix of order  $2 \times 2$  was:

$$W = \frac{1}{2} G(u)\nabla' + \frac{1}{2} \nabla(u')G + \frac{1}{2} u'\nabla(G) + w(G_2 + \gamma G_3) \quad (14)$$

where

$$u \equiv \{u v\} \text{ and } \nabla \equiv \left\{ \frac{\partial}{\partial \alpha} \frac{\partial}{\partial \beta} \right\}$$

By applying the stress-strain relation, the stress matrix of order  $2 \times 2$  omits the no-energy components, (normal shear stresses);

$$A^{-1} P A^{-1} = \frac{E}{1+\sigma} \left\{ G^{-1} W G^{-1} + \frac{\sigma}{1-\sigma} \Delta G^{-1} \right\} \quad (15)$$

where

$$\Delta = W \cdot G^{-1}$$

What is now sought are the stress equivalents on the middle surface in the form of stress resultants and stress couples.

With conformable orders Equation 14 may be written

$$W = \frac{1}{2} J' (J u) \nabla' + \frac{1}{2} \nabla (u' J') J \quad (16)$$

where

$$u \equiv \{u v w\} \text{ and } \nabla \equiv \left\{ \frac{\partial}{\partial \alpha} \frac{\partial}{\partial \beta} \right\}$$

The strain energy

$$U = \frac{1}{2} \int_V A^{-1} P A^{-1} \cdot W dt$$

may then, being specific with displacement vector, be turned into bilinear form:

$$U = \frac{1}{2} \int \int_{-h}^h ([u v w] J') J A^{-1} P A^{-1} \sqrt{g} dy \nabla da db \quad (17)$$

Using Equation 13 and  $J = J_1 + \gamma J_2$ , the operand may be expanded as far as  $\gamma^2$  into:

$$[u_1 v_1 w] J_1' + \gamma [u_1 v_1] J_2' - \gamma \begin{bmatrix} \frac{\partial w}{\partial \alpha} & \frac{\partial w}{\partial \beta} \end{bmatrix} J_1^{-1}$$

because the  $\gamma^2$  terms cancel identically.

The integration over the thickness then falls into two parts:

$$[u_1 v_1 w] J_1' \int_{-h}^h J A^{-1} P A^{-1} \sqrt{g} dy - \left\{ \begin{bmatrix} \frac{\partial w}{\partial \alpha} & \frac{\partial w}{\partial \beta} \end{bmatrix} J_1^{-1} - [u_1 v_1] J_2' \right\} \int_{-h}^h \gamma J A^{-1} P A^{-1} \sqrt{g} dy \quad (18)$$

This, when the operator is included, gives the strain energy per unit area of the middle surface, the first term due to stress resultants and the second due to stress couples. Let these be denoted respectively by

$$\mathbf{N} \equiv \begin{bmatrix} N_{\alpha\alpha} & N_{\alpha\beta} \\ N_{\beta\alpha} & N_{\beta\beta} \end{bmatrix} \quad \mathbf{M} \equiv \begin{bmatrix} M_{\alpha\alpha} & M_{\alpha\beta} \\ M_{\beta\alpha} & M_{\beta\beta} \end{bmatrix}$$

In this, and throughout the previous publication, the first subscript refers to the *direction* and the second to the *surface*.

The stress resultants and stress couples respectively are given by:

$$J_1 A_1^{-1} \mathbf{N} A_1^{-1} \sqrt{g_1} = \int_{-h}^h J A^{-1} P A^{-1} \sqrt{g} dy \quad (19)$$

$$J_1 A_1^{-1} \mathbf{M} A_1^{-1} \sqrt{g_1} = - \int_{-h}^h \gamma J A^{-1} P A^{-1} \sqrt{g} dy \quad (20)$$

These sign conventions should be universally adopted by engineers because they are logical and easy to memorize:

The upper surface is at  $\gamma = h$ .

The lower surface is at  $\gamma = -h$ .

Positive bending moments produce tension on the under surface.

Positive torsions are in the same direction as positive moments on sides  $\alpha$  increasing and  $\beta$  increasing, respectively.

Positive displacements  $(u, v, w)$  are in the directions of  $(\alpha, \beta, \gamma)$  increasing.

Positive stresses on sides  $(\alpha, \beta, \gamma)$  increasing are in the directions of  $(\alpha, \beta, \gamma)$  increasing.

The stress resultants and stress couples in terms of displacements are obtained by substituting Equation 15 into Equations 19 and 20. **33**

\*The binomial expansions have been introduced for the sake of completeness. In practice, negligibles would be omitted and also secondaries, at least for a first solution. The primary and significant displacement terms are those which occur when strain energy is expressed by products of stress resultants and stress couples with displacements. The latter may be readily obtained from the considerations of the last section of the paper.

In terms of metric components and displacements therefore

$$A_1^{-1} N A_1^{-1} \sqrt{g_1} = \int_{-h}^h (I + \gamma G_1^{-1} G_2) A^{-1} P A^{-1} \sqrt{g} dy$$

$$A_1^{-1} M A_1^{-1} \sqrt{g_1} = - \int_{-h}^h (\gamma I + \gamma^2 G_1^{-1} G_2) A^{-1} P A^{-1} \sqrt{g} dy$$

where  $I$  denotes the unit matrix and  $A^{-1} P A^{-1}$  is defined by Equation 15.

The matrix of direction cosines of the triad of intersections,  $M = A^{-1} J'$ , will be used in arriving at the equations of equilibrium. The normal shear stress resultants, denoted by  $Q \equiv \{Q_\alpha Q_\beta\}$  arise from normal shear stresses  $q = \{q_\alpha q_\beta\}$ .

In augmenting the stress matrix in Equation 19, by putting normal shears in the third row, giving orders of  $3 \times 2$ , denoted by  $\begin{bmatrix} N \\ Q' \end{bmatrix}$

and  $\begin{bmatrix} P \\ q' \end{bmatrix}$ ,  $q$  does not enter into  $N$ ,

and

$$Q_\alpha \frac{\sqrt{g_1}}{a_1} = \int_{-h}^h q_\alpha \frac{\sqrt{g}}{a} dy$$

and

$$Q_\beta \frac{\sqrt{g_1}}{b_1} = \int_{-h}^h q_\beta \frac{\sqrt{g}}{b} dy.$$

—merely a definition.

The equations of equilibrium of stress-resultants are:

$$M_1'^{-1} (M_1' \begin{bmatrix} N \\ Q' \end{bmatrix} A_1^{-1} \sqrt{g_1}) \nabla + \sqrt{g_1} X = 0 \quad (21)$$

This may be expanded by the rules of partial differentiation into

$$\left. \begin{aligned} & \begin{bmatrix} N \\ Q' \end{bmatrix} (A_1^{-1} \sqrt{g_1}) \nabla \quad \dots \quad \dots \quad \dots \quad (i) \\ + & \begin{bmatrix} N \\ Q' \end{bmatrix} A_1^{-1} \sqrt{g_1} \nabla \quad \dots \quad \dots \quad \dots \quad (ii) \\ + & E_1^{-1} M_1 (M_1') \begin{bmatrix} N \\ Q' \end{bmatrix} A_1^{-1} \sqrt{g_1} \nabla \quad \dots \quad \dots \quad (iii) \end{aligned} \right\} \quad (22)$$

since  $E = M M'$ .

In passing from sides  $(\alpha, \beta)$  to  $(\alpha + d\alpha, \beta + d\beta)$  of the elemental area

of the middle surface, the resultant forces, to be balanced by the applied loads, are in Equation 22 divided into:

- (i) Due to changes of areas of right cross-sections
- (ii) Due to changes of stresses
- (iii) Due to changes of directions.

In connexion with (iii) above, changes of direction produce resultants in the directions of the triad of normals,  $(l m n)$  being common to both sets. Pre-multiplications by  $E_1^{-1}$  transforms these resultants into the statically equivalent forces in the directions of the triad of intersections, where

$$E_1 \equiv \begin{bmatrix} 1 & \cos\theta_1 & . \\ \cos\theta_1 & 1 & . \\ . & . & 1 \end{bmatrix}$$

The normal shear stress resultants enter into Equation 21 in a secondary capacity. They should be found from the equations of equilibrium of stress couples, which by similar reasoning are:

$$M_1'^{-1} (M_1' M A_1^{-1} \sqrt{g_1}) \nabla + \sqrt{g_1} Q = 0 \quad (23)$$

There is a third, trivial, equation of equilibrium of couples about the normal, which can be shown to be identically satisfied by stress-resultants and stress-couples in terms of displacements. To arrive at this equation, Equation 23 has to be entirely recast into couples about the normals to the curvilinear surfaces, with strict sign conventions for the handing of couples.

In this paper, a self-contained treatment has been sacrificed to the exigencies of length, which has necessitated the many references to the 'previous publication'. An example is precluded for the same reason.

A suitable example to illustrate the method would be one in which the three simultaneous equations of displacements at a grid point could be arrived at before putting in numerical coefficients for solution. Both circular and non-circular cylindrical shells fall into this category. There now seems to be general agreement that the hyperboloid, the simplest form of which has middle surface  $z = kxy$ , cannot be designed by the membrane theory and demands a flexural solution for static equilibrium and stability. Unfortunately that type cannot be taken so far before turning over to numerical methods. Although electronic digital computers have been demanded for the solution of shells of any shape definable in curvilinear co-ordinates, the simple hyperbolic paraboloid might be tackled on these lines by expert Relaxationists using their classical methods.

(1) JENKINS, R. S. Theory of new forms of shell, *Proceedings of a Symposium on Concrete Shell Roof Construction*, 1952, pp. 132-135. Cement and Concrete Association, 1954.

## Membrane theory in general co-ordinates by matrix-tensor methods

### Matrix algebra

A plain vector means a column vector as denoted by the first below. The row vector is the transpose of the first as denoted by the second below.

$$v \equiv \{v_1 \ v_2 \ v_3\} \quad v^* \equiv [v_1 \ v_2 \ v_3]$$

It is assumed that the rules for ordinary matrix multiplication and inversion are known. The matrix handling of Christoffel symbols derives from matrix scalar products.

When  $D \equiv [d_{jk}]$  and  $F = [f_{jk}]$

the scalar product  $D \cdot F = d_{jk} f_{jk}$  (summation convention)

the rule for the scalar product of matrix products can then be obtained by the summation convention:

$$\begin{aligned} A B C \cdot F &= B \cdot A^* F C^* \\ a_{ij} b_{rs} c_{st} f_{il} &= b_{rs} a_{ij} f_{il} c_{st} \end{aligned} \quad (1)$$

When one of the matrices is the open product of two vectors, the scalar product is equivalent to a bilinear form.

$$A \cdot b c^* = b^* A c \quad (2)$$

Differentiation of a determinant,  $\frac{\partial}{\partial \eta} |A|$ , may be equated to a scalar

product. By the rules of partial differentiation, this is equal to a sum of determinants where the only changes from  $|A|$  are that the first row is replaced by the derivatives of its components in the first, the second row replaced by the derivatives of its components in the second, and so on. The Laplacian expansions of these determinants

come to the sum of products of the derivatives of the components of the matrix,  $A$ , times their respective cofactors in  $A$ .

$$\text{i.e.} \quad \frac{\partial}{\partial \eta} |A| = \frac{\partial A}{\partial \eta} \cdot \text{Adj } A^* = |A| \frac{\partial A}{\partial \eta} \cdot A^{*-1} \quad (3)$$

The trace of a square matrix is the sum of its leading diagonal components and may be stated as the scalar product,

$$A \cdot I$$

where the unit matrix,  $I = [\delta_{ij}]$ .

### Fundamental angles

If we map space by level surfaces, denoted by column vector

$$\alpha \equiv \{\alpha_1 \ \alpha_2 \ \alpha_3\} \equiv \{\alpha \ \beta \ \gamma\} \quad (4)$$

then the co-ordinate line,  $\alpha$ , is the intersection of the surfaces  $\beta$  and  $\gamma$ , and similarly for the  $\beta$  and  $\gamma$  co-ordinate lines. There are three other lines which are fundamental in analysis, viz. the normals to the level surfaces. The normal to the surface,  $\alpha = \text{constant}$ , is the perpendicular to the lines  $\beta$  and  $\gamma$ , and so on.

The angular relations between these lines can be derived very simply by introducing arbitrary cartesian co-ordinates,

$$x \equiv \{x_1 \ x_2 \ x_3\} \equiv \{x \ y \ z\} \quad (5)$$

From the geometry of the case, the cartesian co-ordinates,  $x$ , are functions of the curvilinear co-ordinates,  $\alpha$ .

Thus one can obtain the fundamental transformation matrix,

$$J = \left[ \frac{\partial x_i}{\partial \alpha_j} \right] = (x) \nabla^* \quad (6)$$

The typical component quoted is understood to be that in the  $i$ th row and  $j$ th column of the matrix.

The last in Equation 6 is the open product of  $(x)$  and  $\nabla^*$ , the operand being enclosed in round brackets.

The vector operators are in the manner of denoting column vectors to save space,

$$\nabla \equiv \left\{ \frac{\partial}{\partial \alpha_1} \frac{\partial}{\partial \alpha_2} \frac{\partial}{\partial \alpha_3} \right\} \equiv \left\{ \frac{\partial}{\partial \alpha} \frac{\partial}{\partial \beta} \frac{\partial}{\partial \gamma} \right\} \quad (7)$$

$$\nabla_x \equiv \left\{ \frac{\partial}{\partial x_1} \frac{\partial}{\partial x_2} \frac{\partial}{\partial x_3} \right\} \equiv \left\{ \frac{\partial}{\partial x} \frac{\partial}{\partial y} \frac{\partial}{\partial z} \right\} \quad (8)$$

The prototypes of contravariant and covariant vector-tensors, respectively, are shown in the well-known transformations,

$$dx = J da \quad (9)$$

$$\nabla = J^* \nabla_x \quad (10)$$

The covariant metric-tensor,  $G$ , is derived from Equation 9 to obtain quadratic forms for the invariant square of the distance to a neighbouring point.

$$(ds)^2 = dx^* G_x dx = dx^* dx \text{ since } G_x = I \\ = da^* J^* J da = da^* G da \\ \text{i.e. } G = J^* G_x J = J^* J = [g_{ij}] \quad (11)$$

$$\text{where } g_{ij} = \frac{\partial x_k}{\partial \alpha_i} \frac{\partial x_k}{\partial \alpha_j}$$

summed over the repeated indices  $k = 1, 2$  and  $3$ . This is the summation convention due to Einstein.

The determinant of the metric is denoted by

$$g = |G| \text{ so that } \sqrt{g} = |J|.$$

The reverse transformation is also required and may be denoted by symbolic components, but since they have to be functions of  $\alpha$ , it is necessary in practice to find the reciprocal matrix.

$$J^{-1} = \left[ \frac{\partial \alpha_i}{\partial x_j} \right] = \frac{1}{\sqrt{g}} \text{Adj } J \quad (12)$$

where  $\text{Adj } J$  is the matrix of the cofactors of  $J^*$ .

The reciprocal of  $G$  is the contravariant metric-tensor.

$$G^{-1} = [g^{ij}] = J^{-1} G_x^{-1} J^{*-1} = J^{-1} J^{*-1} \quad (13)$$

$$\text{where } g^{ij} = \frac{\partial \alpha_i}{\partial x_k} \frac{\partial \alpha_j}{\partial x_k}$$

Sub<sub>x</sub> always denotes components in the cartesian co-ordinates.

The transformations, 9, 10, 11 and 13, demonstrate the transformation laws for covariant and contravariant matrix-tensors.

Because of contravariant transformation, 9, the co-ordinate indices are often put superior. As pointed out by Schrödinger, the co-ordinates themselves are neither covariant nor contravariant and, anyway, the subscript is justified by the covariant vector

$$\nabla = \left\{ \frac{\partial}{\partial \alpha_1} \frac{\partial}{\partial \alpha_2} \frac{\partial}{\partial \alpha_3} \right\}$$

and is much more convenient.

Other contravariant vector components will be denoted by superior indices.

To return to the angular relations and other matters, such as the transition from physical components to tensor components, it is convenient to set up two diagonal matrices.

$$A = \text{Diag } [\sqrt{g_{ij}}] \text{ and } B = \text{Diag } [\sqrt{g^{ij}}] \text{ (not summed)}$$

When the direction cosines in relation to the cartesian lines are arranged row by row,  $[l, m, n]$  those of the  $\{\alpha \beta \gamma\}$  co-ordinate lines are,

$$M = A^{-1} J^* \quad (14)$$

those of the normal lines to the surfaces are,

$$N = B^{-1} J^{-1} \quad (15)$$

Thus the cosines of the angles between the co-ordinate lines are

$$MM^* = A^{-1} G A^{-1}$$

between the normal lines to the surfaces are

$$NN^* = B^{-1} G^{-1} B^{-1}$$

and between the two sets are

$$MN^* = NM^* = A^{-1} B^{-1}$$

It may also be observed that the sines of the angles between the co-ordinate lines can be obtained from the leading cofactors of  $A^{-1} G A^{-1}$ ,

$$\text{e.g. } \sin(\alpha\beta) = \sin \omega_\gamma = \frac{\sqrt{g g^{\gamma\gamma}}}{\sqrt{g_{\alpha\alpha} g_{\beta\beta}}}$$

Similarly, the leading cofactors of  $B^{-1} G^{-1} B^{-1}$  give the sines of the angles between the normals to the co-ordinate surfaces,

$$\text{e.g. } \sin(\bar{\alpha}\bar{\beta}) = \frac{\sqrt{g^{\gamma\gamma}}}{\sqrt{g^{\alpha\alpha} g^{\beta\beta}}}$$

### Equations of equilibrium

A parallelepiped is bounded by the co-ordinate surfaces at a point  $(\alpha, \beta, \gamma)$  and a neighbouring point  $(\alpha + d\alpha, \beta + d\beta, \gamma + d\gamma)$ .

The volume of the parallelepiped is  $\sqrt{g} da d\beta d\gamma$ .

When, for convenience,  $da = d\beta = d\gamma = 1$ , the length of the co-

ordinate line edges are the components of  $A$ . The perpendicular distances between the co-ordinate surfaces are the components of  $B^{-1}$ . The areas of the bounding surfaces are the components of  $B\sqrt{g}$ .

The transformation of physical components of stress from the cartesian line directions to the general co-ordinate line directions is obtained from two tetrahedra on a common base.

The physical components of stress on the remaining sides of the tetrahedra are denoted by  $P_x$  and  $\bar{P}$ , where  $\bar{P} = [\sigma_{ij}]$ ; the component in the  $i$ th row and  $j$ th column denoting the stress in the direction  $i$  on the surface  $j$ .

The stress resultants on the base are statically equivalent and related by the transformation

$$f_x = M^* f = J A^{-1} f \quad (16)$$

The projection of the areas of the  $\{\alpha, \beta, \gamma\}$  faces of one tetrahedron on to the  $\{x y z\}$  faces of the other is given by

$$a_x = N^* a = J^{*-1} B^{-1} a \quad (17)$$

Now

$$f_x = P_x a_x \text{ and } f = \bar{P} a$$

so that

$$f_x = M^* f = M^* \bar{P} a = M^* \bar{P} N^{*-1} a_x$$

i.e.

$$P_x = M^* \bar{P} N^{*-1} = J A^{-1} \bar{P} B J^* \quad (18)$$

This is the contravariant transformation, so that the stress matrix-tensor is

$$\bar{P} = [\tau^{ij}] = A^{-1} \bar{P} B \text{ and } P_x = J \bar{P} J^* \quad (19)$$

At the end of the computation, one transforms back to physical components. We do not mean those in the oblique  $(\alpha, \beta, \gamma)$  directions, denoted by  $\bar{P}$ , which have been introduced only as a step to the tensor components for the computation. We refer to physical components in the original cartesian directions or other orthogonal components useful for boundary conditions, etc.

For example, we may orthogonalize on a  $\gamma$  surface and a  $\beta$  line. The co-ordinates are then

$$\{\eta s \rho\},$$

where the  $\rho$  line is the normal to the  $\gamma$  surface, the  $s$  line is coincident with the  $\beta$  line and  $\eta$  is the perpendicular to the  $\beta$  line in that surface.

Since metric components are independent of the cartesian set, it is best to define the transformation in terms of these components.

The transformation of parallelepiped components of force are easily visualized.

When

$$f_\eta = (f_\eta f_s f_\rho)$$

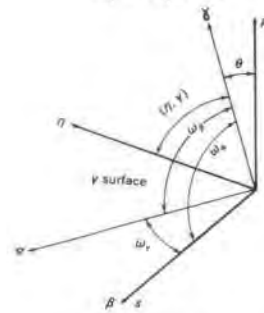

$$f_\eta = L^* f \text{ is then}$$

$$\begin{bmatrix} f_\eta \\ f_s \\ f_\rho \end{bmatrix} = \begin{bmatrix} \sin \omega_\gamma & & \sqrt{\sin^2 \omega_\alpha - \cos^2 \theta} \\ \cos \omega_\gamma & 1 & \cos \omega_\alpha \\ & & \cos \theta \end{bmatrix} \begin{bmatrix} f_\alpha \\ f_\beta \\ f_\gamma \end{bmatrix}$$

where  $\cos \theta = \frac{1}{\sqrt{g_\gamma g^{\gamma\gamma}}}$  is obtained from  $A^{-1} B^{-1}$ .

So, when the new transformation in place of  $J$  is denoted by  $K$ ,

$$P_\eta = K \bar{P} K^* \text{ (contravariant)}$$

$$\text{where } K = L^* A = \begin{bmatrix} \sqrt{\frac{g g^{\gamma\gamma}}{g_\beta}} & & \sqrt{\frac{g g^{\alpha\alpha}}{g_\beta}} \frac{1}{g^{\gamma\gamma}} \\ \frac{g_{\alpha\beta}}{\sqrt{g_\beta}} & \sqrt{g_\beta} & \frac{g_{\alpha\gamma}}{\sqrt{g_\beta}} \\ & & \frac{1}{\sqrt{g^{\gamma\gamma}}} \end{bmatrix}$$

It may be shown, as we would expect, that  $K^* K = G$ , and  $|K| = \sqrt{g}$ .

From the orthogonal physical stress components,  $P_x$  or  $P_\eta$ , one may find the principal stresses equal to the roots of the characteristic equation,

$$\left| \lambda I - P_x \right| = \left| \lambda I - P_\eta \right| = 0 = (\lambda - \lambda_1) (\lambda - \lambda_2) (\lambda - \lambda_3) \quad (20)$$

since both determinants =  $g \mid \lambda G^{-1} - \ddot{P} \mid$

Principal stress resultants and their directions are considered in detail for the two-dimensional case of the membrane theory of shells on pages 39 to 40.

The equations of equilibrium are obtained by substituting in those of the cartesian co-ordinates,

$$(P_x) \nabla_x + X_x = 0 \quad (21)$$

$$\text{i.e. } (J \ddot{P} J^*) J^{*-1} \nabla + J \dot{X} = 0 \quad (22)$$

because the statically equivalent components of body forces are

$$X_x = M^* \bar{X} = J A^{-1} \bar{X} = J \dot{X} \quad (23)$$

so that the physical components are related to the contravariant tensor components by

$$\bar{X} = \{X^\alpha X^\beta X^\gamma\} = A^{-1} \dot{X} \quad (24)$$

When Equation 22 is expanded by the rules of partial differentiation and pre-multiplied by  $J^{-1}$ ,

$$(\ddot{P}) \nabla + \ddot{P} (J^*) J^{*-1} \nabla + J^{-1} (J) \ddot{P} \nabla + \dot{X} = 0 \quad (25)$$

Now from the equivalence of bilinear forms to matrix scalar products, the operator may be moved next to the operand, the scalar being underscored,

$$P (J^*) J^{*-1} \nabla = P \nabla (x^*) J^{*-1} \nabla = P \nabla J^{*-1} \cdot (x) \nabla^*$$

$$= P \nabla (J) \cdot J^{*-1} = \frac{1}{\sqrt{g}} P \nabla (\sqrt{g}) = \left[ r^{ri} \frac{\partial a_i}{\partial x_k} \frac{\partial^2 x_k}{\partial a_i \partial a_j} \right] \quad (26)$$

$$J^{-1} (J) P \nabla = J^{-1} (x) \nabla^* P \nabla = J^{-1} (x) \nabla \nabla^* \cdot P = \left[ r^{ri} \frac{\partial a_r}{\partial x_k} \frac{\partial^2 x_k}{\partial a_i \partial a_j} \right] \quad (27)$$

Thus the equations of equilibrium may be stated in matrix notation,  $(\ddot{P}) \nabla + \dot{X} = 0$

where the bold face  $\nabla$  denotes covariant derivatives.

$$\text{i.e. } (\ddot{P}) \nabla + \frac{1}{\sqrt{g}} \ddot{P} \nabla (\sqrt{g}) + J^{-1} (J) \ddot{P} \nabla + \dot{X} = 0 \quad (28)$$

or in tensor notation,

$$r^{ri} |_{j} + X^r = 0$$

$$\text{i.e. } \frac{\partial r^{ri}}{\partial a_j} + r^{ri} \Gamma_{ij} + r^{ri} \Gamma_{ij} + X^r = 0 \quad (29)$$

where  $r \equiv (\alpha, \beta, \gamma)$  denotes the first, second or third equation.

It should be noted that the same equations are obtained when the variables are further changed to  $\ddot{P} \sqrt{g}$  and  $\dot{X} \sqrt{g}$  from

$$(J \ddot{P} \sqrt{g}) \nabla + \sqrt{g} J \dot{X} = 0 \quad (30)$$

$$\text{i.e. } (\ddot{P} \sqrt{g}) \nabla + J^{-1} (J) \ddot{P} \sqrt{g} \nabla + \sqrt{g} \dot{X} = 0 \quad (31)$$

which brings in the nomenclature of *covariant differentiation*, of a contravariant tensor,

$$(\ddot{P} \sqrt{g}) \nabla + \sqrt{g} \dot{X} = 0$$

The terminology is derived from the fact that  $\nabla$  is a covariant vector. This is never explained in tensor calculus textbooks, whereas it is shown up by matrix-tensor methods.

The form of Equation 30 can be obtained by a physical argument, instead of the substitution.

Consider the parallelepiped with  $da = d\beta = d\gamma = 1$ .

The stress resultants on the surfaces are  $\bar{P} B \sqrt{g}$  and the body forces are  $\sqrt{g} X_x$ .

Because of changes of direction in going from surfaces  $\alpha$  to  $\alpha + da$ , one turns the stress resultants into the cartesian directions, so that the equations of equilibrium in those directions are

$$(M^* \bar{P} B \sqrt{g}) \nabla + \sqrt{g} X_x = 0$$

so, with new changes of variables,

$$P = A^{-1} \bar{P} B \sqrt{g} \text{ and } \sqrt{g} X_x = J X$$

one obtains

$$J^{-1} (J P) \nabla + X = 0 \quad (32)$$

or

$$(P) \nabla + X = 0$$

## MEMBRANE THEORY

For a dome, the cartesian co-ordinate,  $z = \text{constant}$ , is taken as a horizontal plane.

In a self-weight type of loading, applied forces are known, in the cartesian directions,

$$X_x = 0, Y_x = 0, Z_x = \text{self-weight} + \text{applied forces per unit area}$$

$$\text{On the middle surface } J = \begin{bmatrix} \frac{\partial x}{\partial a} & \frac{\partial x}{\partial \beta} \\ \frac{\partial y}{\partial a} & \frac{\partial y}{\partial \beta} \\ \frac{\partial z}{\partial a} & \frac{\partial z}{\partial \beta} \end{bmatrix}$$

The components of a third column for a full  $J$  are those of the unit vector of the normal, denoted by  $l = \{l m n\}$ . These components are proportioned to their cofactors in  $J$ , denoted by  $\{j_1 j_2 j_3\}$

$$j_1 = \begin{vmatrix} \frac{\partial y}{\partial a} & \frac{\partial y}{\partial \beta} \\ \frac{\partial z}{\partial a} & \frac{\partial z}{\partial \beta} \end{vmatrix} \quad j_2 = - \begin{vmatrix} \frac{\partial x}{\partial a} & \frac{\partial x}{\partial \beta} \\ \frac{\partial z}{\partial a} & \frac{\partial z}{\partial \beta} \end{vmatrix} \quad j_3 = \begin{vmatrix} \frac{\partial x}{\partial a} & \frac{\partial x}{\partial \beta} \\ \frac{\partial y}{\partial a} & \frac{\partial y}{\partial \beta} \end{vmatrix}$$

$$\text{Then } l \equiv \{l m n\} \equiv \frac{1}{\sqrt{g}} \{j_1 j_2 j_3\} \quad (34)$$

and

$$\sqrt{g} = \sqrt{j_1^2 + j_2^2 + j_3^2} \quad (35)$$

The components of the metric are given by  $G = J^* J$ , hence  $A$  and  $B$ .

The tangential contravariant stress resultants are defined, in terms of physical components, by

$$N = A^{-1} \bar{N} B \sqrt{g}$$

In two dimensions,

$$A = \begin{bmatrix} \sqrt{g_\alpha} & \\ & \sqrt{g_\beta} \end{bmatrix} \text{ and } B \sqrt{g} = \begin{bmatrix} \sqrt{g_\beta} & \\ & \sqrt{g_\alpha} \end{bmatrix}$$

Thus the tensor components are related to the physical components by the symmetrical matrices,

$$N = \begin{bmatrix} N^{\alpha\alpha} & N^{\alpha\beta} \\ N^{\beta\alpha} & N^{\beta\beta} \end{bmatrix} = \begin{bmatrix} \bar{N}_{\alpha\alpha} \sqrt{\frac{g_\beta}{g_\alpha}} & \bar{N}_{\alpha\beta} \\ \bar{N}_{\beta\alpha} & \bar{N}_{\beta\beta} \sqrt{\frac{g_\alpha}{g_\beta}} \end{bmatrix} \quad (36)$$

## Third equation of equilibrium

The equations of equilibrium are  $(JN) \nabla + \sqrt{g} X_x = 0$  and in the tangential directions  $J^{-1} (JN) \nabla + \sqrt{g} J^{-1} X_x = 0$ .

The last row of the full  $J^{-1}$  is  $l^*$ .

The third equation is thus,

$$l^* (JN) \nabla + \sqrt{g} l^* X_x = 0 \quad (37)$$

$$\text{i.e. } l^* J (N) \nabla + l^* (J) N \nabla + \sqrt{g} l^* X_x = 0$$

The components of  $l$  are the direction cosines of the normal, so that  $l^* J = 0$ , and

$$l^* (J) N \nabla = - (l^*) J N \nabla = - N \cdot J^* (l) \nabla^* = - N \cdot G_2$$

where  $G_2$  is the covariant curvature metric tensor.

$$G_2 = J^* (l) \nabla^* = - \frac{1}{\sqrt{g}} \left[ j_k \frac{\partial^2 x_k}{\partial a_i \partial a_j} \right] \equiv \begin{bmatrix} k_{\alpha\alpha} & k_{\alpha\beta} \\ k_{\beta\alpha} & k_{\beta\beta} \end{bmatrix} \quad (38)$$

Thus the well-known third equation is

$$N^{\alpha\alpha} k_{\alpha\alpha} + 2N^{\alpha\beta} k_{\alpha\beta} + N^{\beta\beta} k_{\beta\beta} = h Z_x \quad (39)$$

$$\text{since } X_x = Y_x = 0 \text{ and } h = j_3 = \begin{bmatrix} \frac{\partial x}{\partial a} & \frac{\partial x}{\partial \beta} \\ \frac{\partial y}{\partial a} & \frac{\partial y}{\partial \beta} \end{bmatrix}$$

## The stress function

The function is to satisfy the first two equations of equilibrium

$$(HN) \nabla = 0 \text{ since } X_x = Y_x = 0 \quad (40)$$

where  $H$  denotes the first two rows of  $J$ , i.e. the matrix of the determinant above.

Now the equilibrium equations have been obtained by changing the directions of the stresses into the cartesian directions. Thus, when physical components, as in Equation 36, are based on  $G_\alpha = H^* H$ , one has the horizontal components of stress resultants on the plane  $z = \text{constant}$ . This assumes the curvilinear co-ordinates are vertical surfaces. The arrangement is known as the affine shell.

Therefore, the stress function is the ordinate on the affine shell and boundary ring tensions will be the horizontal component of boundary tension. This must be clearly understood in the following.

The Airy stress function in the cartesian co-ordinates  $(x, y)$  is defined by

$$\text{Adj } N_x = \nabla_x \nabla^* (f) = \nabla_x (\xi^* x) \quad (41)$$

$$\text{where } \xi^* x = \begin{bmatrix} \frac{\partial f}{\partial x} & \frac{\partial f}{\partial y} \end{bmatrix} = \nabla^* (f)$$

In the general co-ordinates  $\xi_x$  must be retained since the stresses have been turned into the cartesian directions, thus

$$\text{Adj } (HN) = \nabla (\xi^* x) \text{ where } \nabla = \left\{ \frac{\partial}{\partial a} \frac{\partial}{\partial \beta} \right\} \quad (42)$$

When  $\xi^* = \nabla^* (f)$ , it is evident from  $\nabla = H^* \nabla_x$  that  $\xi^* x = \xi^* H^{-1}$ .

Thus  $\text{Adj } N \text{ Adj } H = \nabla(\xi^* H^{-1})$  or  $h \text{ Adj } N = \nabla(\xi^* H^{-1})H$   
 $= \nabla \nabla^*(f) - \nabla \xi^* H^{-1}(H)$  (43)

The second term,  
 $-\nabla \xi^* H^{-1}(H) = -\nabla \xi^* H^{-1}(x) \nabla^* = -H^{-1} \cdot \xi(x^*) \nabla \nabla^*$

The components of  $h \text{ Adj } N$  are therefore,

$$\nabla \nabla^*(f) = \frac{\partial^2 f}{\partial a_i \partial a_i} - \frac{\partial f}{\partial a_m} \frac{\partial a_m}{\partial x_k} \frac{\partial^2 x_k}{\partial a_i \partial a_i} \equiv \frac{\partial^2 f}{\partial a_i \partial a_i} - \frac{\partial f}{\partial a_m} \Gamma^m_{ii} \quad (44)$$

$$\frac{\partial a_m}{\partial x_k} \text{ are components of } H^{-1} \equiv \begin{bmatrix} \frac{\partial a}{\partial x} & \frac{\partial a}{\partial y} \\ \frac{\partial \beta}{\partial x} & \frac{\partial \beta}{\partial y} \end{bmatrix} = \frac{1}{h} \begin{bmatrix} \frac{\partial y}{\partial \beta} & -\frac{\partial x}{\partial \beta} \\ -\frac{\partial y}{\partial a} & \frac{\partial x}{\partial a} \end{bmatrix}$$

When Christoffel components are denoted by

$$\frac{\partial a}{\partial x_k} \frac{\partial^2 x_k}{\partial a^2} = (a, aa), \quad \frac{\partial \beta}{\partial x_k} \frac{\partial^2 x_k}{\partial a \partial \beta} = (\beta, a\beta), \text{ etc.}$$

summed over  $x_k = x, y$ .

The stress resultants in terms of stress functions are

$$\begin{aligned} hN^{\beta\beta} &= \frac{\partial^2 f}{\partial a^2} - \frac{\partial f}{\partial a} (a, aa) - \frac{\partial f}{\partial \beta} (\beta, aa) \\ -hN^{\alpha\beta} &= \frac{\partial^2 f}{\partial a \partial \beta} - \frac{\partial f}{\partial a} (a, a\beta) - \frac{\partial f}{\partial \beta} (\beta, a\beta) \\ hN^{\alpha\alpha} &= \frac{\partial^2 f}{\partial \beta^2} - \frac{\partial f}{\partial a} (a, \beta\beta) - \frac{\partial f}{\partial \beta} (\beta, \beta\beta) \end{aligned} \quad (45)$$

### Boundary condition

Assume the boundary is a tension ring on  $a = \text{constant}$ .

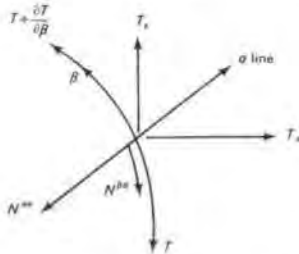

When  $T$  denotes the horizontal component of physical boundary tension,

$$T_x = \frac{\partial x}{h_\beta \partial \beta} T \quad T_y = \frac{\partial y}{h_\beta \partial \beta} T$$

where  $\text{Diag } [H^*H] = \begin{bmatrix} h^2_\alpha & \\ & h^2_\beta \end{bmatrix}$

The equation of equilibrium at the boundary is

$$H \begin{bmatrix} N^{\alpha\alpha} \\ N^{\beta\alpha} \end{bmatrix} = \begin{bmatrix} \frac{\partial T_x}{\partial \beta} \\ \frac{\partial T_y}{\partial \beta} \end{bmatrix}$$

i.e.  $\frac{\partial^2 f}{\partial \beta \partial y} = \frac{\partial}{\partial \beta} \left( \frac{\partial x}{h_\beta \partial \beta} T \right) \quad -\frac{\partial^2 f}{\partial a \partial x} = \frac{\partial}{\partial \beta} \left( \frac{\partial y}{h_\beta \partial \beta} T \right)$

When  $\frac{\partial f}{\partial \beta} = 0$  on the boundary, one obtains

$$\begin{aligned} \frac{\partial x}{h_\beta \partial \beta} T &= \frac{\partial f}{\partial y} = -\frac{\partial f}{\partial a} \frac{\partial a}{\partial y} - \frac{\partial f}{\partial \beta} \frac{\partial \beta}{\partial y} = -\frac{1}{h} \frac{\partial x}{\partial \beta} \frac{\partial f}{\partial a} + \frac{1}{h} \frac{\partial x}{\partial a} \frac{\partial f}{\partial \beta} \\ \frac{\partial y}{h_\beta \partial \beta} T &= -\frac{\partial f}{\partial x} = -\frac{\partial f}{\partial a} \frac{\partial a}{\partial x} - \frac{\partial f}{\partial \beta} \frac{\partial \beta}{\partial x} = -\frac{1}{h} \frac{\partial y}{\partial \beta} \frac{\partial f}{\partial a} + \frac{1}{h} \frac{\partial y}{\partial a} \frac{\partial f}{\partial \beta} \end{aligned}$$

To satisfy both these equations  $\frac{\partial f}{\partial \beta} = 0$ , i.e.  $f = 0$  or constant on the boundary.

Then,

$$T = -\frac{h_\beta}{h} \frac{\partial f}{\partial a} \quad (46)$$

Since,  $h = h_\alpha h_\beta \sin \omega_\alpha$ , when  $\omega_\alpha$  is the obliquity in plane

$$T = -\frac{1}{\sin \omega_\alpha} \frac{\partial f}{h_\alpha \partial a}$$

Therefore, the horizontal component of the boundary tension is equal to the slope of the stress function perpendicular to the plane projection of the boundary.

When the  $\eta$  line is perpendicular to, and the  $s$  line is coincident with, the boundary, the boundary tension in terms of the slope of the stress function, as obtained above, may be shown in the following diagram.

$$T = -\frac{\partial f}{\partial \eta} \quad T_x = \frac{\partial f}{\partial y} \quad T_y = -\frac{\partial f}{\partial x}$$

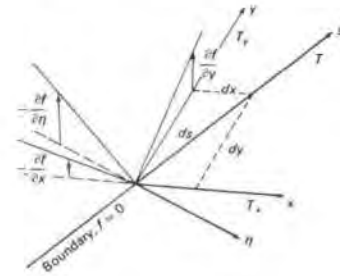

We see that any horizontal component of the boundary tension is equal to the slope of the stress function perpendicular to it.  $h$  has been retained in Equation 45 to make  $f$  an invariant, that is independent of the co-ordinates.

Although Equation 46 is required for the work in general co-ordinates there is a very simple proof about the slope of the stress function at the boundary.

For a small distance along the boundary we may set up polar co-ordinates in the affine plane, where  $r$  is the radius and  $\varphi$  is the angle from the given point. Let  $s$  be the arc length along the boundary from the given point. Let  $\bar{Q}$  denote horizontal projections of stress resultants.

By proceeding according to the general co-ordinates, it is soon shown that, when  $f = 0$  on the boundary,

$$\bar{Q}_{rr} = \frac{1}{r} \frac{\partial f}{\partial r} = -\frac{1}{r} T \quad \text{hence } T = -\frac{\partial f}{\partial r}$$

$$\bar{Q}_{r\varphi} = -\frac{\partial^2 f}{\partial r \partial s} = \frac{\partial T}{\partial s} \quad \text{giving the same result,}$$

where  $r$  is now the radius at the given point on the boundary.

If the boundary is a straight line we obtain, as expected, that  $\bar{N}_{rr} = 0$ , but  $T = -\frac{\partial f}{\partial r}$  from the shear equilibrium.

### The differential equation

The stress resultants in terms of the stress function are substituted in the third equation of equilibrium.

$$\begin{aligned} k_{\alpha\alpha} \frac{\partial^2 f}{\partial \beta^2} - 2k_{\alpha\beta} \frac{\partial^2 f}{\partial a \partial \beta} + k_{\beta\beta} \frac{\partial^2 f}{\partial a^2} \\ - \left\{ k_{\alpha\alpha} (a, \beta\beta) - 2k_{\alpha\beta} (a, a\beta) + k_{\beta\beta} (a, aa) \right\} \frac{\partial f}{\partial a} \\ - \left\{ k_{\alpha\alpha} (\beta, \beta\beta) - 2k_{\alpha\beta} (\beta, a\beta) + k_{\beta\beta} (\beta, aa) \right\} \frac{\partial f}{\partial \beta} = h^2 Z_x \end{aligned} \quad (47)$$

where  $f = 0$  on the boundary.

All the coefficients are variable and will be given in definite terms for the particular example for a numerical program. This would seem preferable to a program in general terms because, in many cases, the twist  $k_{\alpha\beta}$ , will be zero. However, it is a point for discussion with the programmers.

### Physical interpretation and total equilibrium

By definition

$$\begin{aligned} \sqrt{g_\alpha} &= \left\{ \left( \frac{\partial x}{\partial a} \right)^2 + \left( \frac{\partial y}{\partial a} \right)^2 + \left( \frac{\partial z}{\partial a} \right)^2 \right\}^{\frac{1}{2}} = \sqrt{h^2_\alpha + \left( \frac{\partial x}{\partial a} \right)^2} \\ \sqrt{g_\beta} &= \left\{ \left( \frac{\partial x}{\partial \beta} \right)^2 + \left( \frac{\partial y}{\partial \beta} \right)^2 + \left( \frac{\partial z}{\partial \beta} \right)^2 \right\}^{\frac{1}{2}} = \sqrt{h^2_\beta + \left( \frac{\partial x}{\partial \beta} \right)^2} \end{aligned}$$

where  $h_\alpha da$  and  $h_\beta d\beta$  are the co-ordinate line lengths in plan in moving from point  $(a, \beta)$  to  $(a+da, \beta+d\beta)$ , when  $a$  and  $\beta$  are vertical surfaces.

We make a typical sketch of an element on the middle surface and the affine plane.

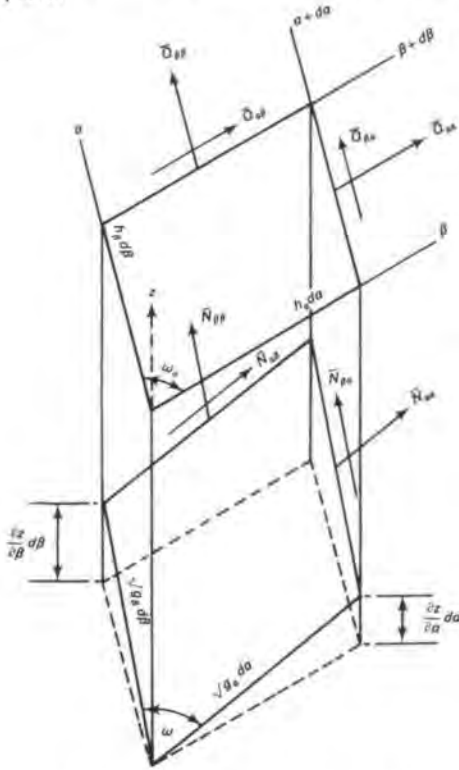

The projection of the physical components to the affine surface are denoted by  $\bar{O}$ .

Thus,

$$\bar{O}_{\alpha\alpha} h_\beta d\beta = \bar{N}_{\alpha\alpha} \sqrt{g_\beta} d\beta \frac{h_\alpha}{\sqrt{g_\alpha}}, \quad \bar{O}_{\alpha\beta} h_\alpha d\alpha = \bar{N}_{\alpha\beta} \sqrt{g_\alpha} d\alpha \frac{h_\alpha}{\sqrt{g_\alpha}}$$

$$\bar{O}_{\beta\alpha} h_\beta d\beta = \bar{N}_{\beta\alpha} \sqrt{g_\beta} d\beta \frac{h_\beta}{\sqrt{g_\beta}}, \quad \bar{O}_{\beta\beta} h_\alpha d\alpha = \bar{N}_{\beta\beta} \sqrt{g_\alpha} d\alpha \frac{h_\beta}{\sqrt{g_\beta}}$$

Since the contravariant components are related to the physical components by the first below, the second gives the relation to the components in plan.

$$\begin{bmatrix} N^{\alpha\alpha} & N^{\alpha\beta} \\ N^{\beta\alpha} & N^{\beta\beta} \end{bmatrix} = \begin{bmatrix} \bar{N}_{\alpha\alpha} \sqrt{g_\beta} & \bar{N}_{\alpha\beta} \\ \bar{N}_{\beta\alpha} & \bar{N}_{\beta\beta} \sqrt{g_\alpha} \end{bmatrix} = \begin{bmatrix} \bar{O}_{\alpha\alpha} \frac{h_\beta}{h_\alpha} & \bar{O}_{\alpha\beta} \\ \bar{O}_{\beta\alpha} & \bar{O}_{\beta\beta} \frac{h_\alpha}{h_\beta} \end{bmatrix}$$

The vertical components of the stress resultants are

$$\bar{N}_{\alpha\alpha} \sqrt{g_\beta} d\beta \frac{\partial z}{\sqrt{g_\alpha} \partial \alpha} + \bar{N}_{\beta\alpha} \sqrt{g_\beta} d\beta \frac{\partial z}{\sqrt{g_\beta} \partial \beta} = \left\{ \frac{\partial z}{\partial \alpha} N^{\alpha\alpha} + \frac{\partial z}{\partial \beta} N^{\beta\alpha} \right\} d\beta$$

$$\bar{N}_{\alpha\beta} \sqrt{g_\alpha} d\alpha \frac{\partial z}{\sqrt{g_\alpha} \partial \alpha} + \bar{N}_{\beta\beta} \sqrt{g_\alpha} d\alpha \frac{\partial z}{\sqrt{g_\beta} \partial \beta} = \left\{ \frac{\partial z}{\partial \alpha} N^{\alpha\beta} + \frac{\partial z}{\partial \beta} N^{\beta\beta} \right\} d\alpha$$

When we continue the turning of the stress vectors on the edges into the cartesian directions, we come to the affine plane.

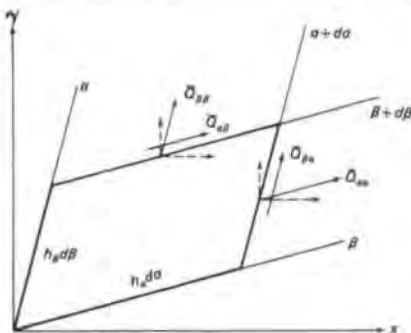

In the x direction,

$$\bar{O}_{\alpha\alpha} h_\beta d\beta \frac{\partial x}{h_\alpha \partial \alpha} + \bar{O}_{\beta\alpha} h_\beta d\beta \frac{\partial x}{h_\beta \partial \beta} = \left\{ \frac{\partial x}{\partial \alpha} N^{\alpha\alpha} + \frac{\partial x}{\partial \beta} N^{\beta\alpha} \right\} d\beta$$

$$\bar{O}_{\alpha\beta} h_\alpha d\alpha \frac{\partial x}{h_\alpha \partial \alpha} + \bar{O}_{\beta\beta} h_\alpha d\alpha \frac{\partial x}{h_\beta \partial \beta} = \left\{ \frac{\partial x}{\partial \alpha} N^{\alpha\beta} + \frac{\partial x}{\partial \beta} N^{\beta\beta} \right\} d\alpha$$

Similarly, in the y direction,

$$\bar{O}_{\alpha\alpha} h_\beta d\beta \frac{\partial y}{h_\alpha \partial \alpha} + \bar{O}_{\beta\alpha} h_\beta d\beta \frac{\partial y}{h_\beta \partial \beta} = \left\{ \frac{\partial y}{\partial \alpha} N^{\alpha\alpha} + \frac{\partial y}{\partial \beta} N^{\beta\alpha} \right\} d\beta$$

$$\bar{O}_{\alpha\beta} h_\alpha d\alpha \frac{\partial y}{h_\alpha \partial \alpha} + \bar{O}_{\beta\beta} h_\alpha d\alpha \frac{\partial y}{h_\beta \partial \beta} = \left\{ \frac{\partial y}{\partial \alpha} N^{\alpha\beta} + \frac{\partial y}{\partial \beta} N^{\beta\beta} \right\} d\alpha$$

We see that  $JN$  turns the stress vectors into the cartesian directions. This is not the same as a transformation into cartesian co-ordinates, which we shall come to later.

The equation of equilibrium in the cartesian directions has been given,

$$(JN)\nabla + \sqrt{g} X_s = 0$$

The total equilibrium is therefore

$$\int_{\alpha} \int_{\beta} (JN)\nabla d\alpha d\beta + \int_{\alpha} \int_{\beta} \sqrt{g} X_s d\alpha d\beta = 0$$

Over any closed region we obtain, by Green's theorem, or by writing it out in full,

$$\int_{\alpha} \int_{\beta} (JN)\nabla d\alpha d\beta \text{ is equivalent to the line integrals}$$

$$\oint \left\{ \frac{\partial x}{\partial \alpha} N^{\alpha\alpha} + \frac{\partial x}{\partial \beta} N^{\beta\alpha} \right\} d\beta + \oint \left\{ \frac{\partial x}{\partial \alpha} N^{\alpha\beta} + \frac{\partial x}{\partial \beta} N^{\beta\beta} \right\} d\alpha + \int \int \sqrt{g} X_x d\alpha d\beta = 0$$

$$\oint \left\{ \frac{\partial y}{\partial \alpha} N^{\alpha\alpha} + \frac{\partial y}{\partial \beta} N^{\beta\alpha} \right\} d\beta + \oint \left\{ \frac{\partial y}{\partial \alpha} N^{\alpha\beta} + \frac{\partial y}{\partial \beta} N^{\beta\beta} \right\} d\alpha + \int \int \sqrt{g} Y_x d\alpha d\beta = 0$$

$$\oint \left\{ \frac{\partial z}{\partial \alpha} N^{\alpha\alpha} + \frac{\partial z}{\partial \beta} N^{\beta\alpha} \right\} d\beta + \oint \left\{ \frac{\partial z}{\partial \alpha} N^{\alpha\beta} + \frac{\partial z}{\partial \beta} N^{\beta\beta} \right\} d\alpha + \int \int \sqrt{g} Z_x d\alpha d\beta = 0$$

As stated above, the first line integral is over that part of a closed boundary where  $\alpha = \text{constant}$  and the second over that part where  $\beta = \text{constant}$ .

In our case, we are considering only the vertical load  $Z_x$ , and the last equation states the total equilibrium.

When we set up a rectilinear set of vertical surfaces at a point on the boundary, where the  $\eta$  line is perpendicular to the boundary and the  $s$  line is along the boundary, we find the contravariant components are the same as the horizontal components, i.e.

$$\begin{bmatrix} N^{\eta\eta} & N^{\eta s} \\ N^{s\eta} & N^{ss} \end{bmatrix} = \begin{bmatrix} \bar{N}_{\eta\eta} \frac{\sqrt{g_s}}{\sqrt{g_\eta}} & \bar{N}_{\eta s} \\ \bar{N}_{s\eta} & \bar{N}_{ss} \frac{\sqrt{g_\eta}}{\sqrt{g_s}} \end{bmatrix} = \begin{bmatrix} \bar{O}_{\eta\eta} & \bar{O}_{\eta s} \\ \bar{O}_{s\eta} & \bar{O}_{ss} \end{bmatrix}$$

Hence the affinity.

where

$$\sqrt{g_\eta} = \sqrt{1 + \left( \frac{\partial z}{\partial \eta} \right)^2} \quad \text{and} \quad \sqrt{g_s} = \sqrt{1 + \left( \frac{\partial z}{\partial s} \right)^2}$$

The line integral then becomes, for vertical loads only,

$$\oint \left\{ \frac{\partial z}{\partial \eta} N^{\eta\eta} + \frac{\partial z}{\partial s} N^{s\eta} \right\} ds + \int \int \sqrt{g} Z_x d\alpha d\beta = 0$$

where the last is the same as  $\int_{\alpha} \int_{\beta} \sqrt{g} Z_x d\alpha d\beta$

in which

$$\sqrt{g_x} = \sqrt{1 + \left( \frac{\partial z}{\partial x} \right)^2 + \left( \frac{\partial z}{\partial y} \right)^2}$$

In the case of the boundary of the shell on  $\alpha = \text{constant}$ , the vertical edge load per unit distance is

$$\frac{1}{\sqrt{g_\beta}} \left\{ \frac{\partial z}{\partial \alpha} N^{\alpha\alpha} + \frac{\partial z}{\partial \beta} N^{\beta\alpha} \right\} \quad (48)$$

i.e.  $\left\{ \frac{\partial z}{\sqrt{g_\alpha} \partial \alpha} \bar{N}_{\alpha\alpha} + \frac{\partial z}{\sqrt{g_\beta} \partial \beta} \bar{N}_{\beta\alpha} \right\}$  in physical terms,

Since  $\frac{\partial f}{\partial \beta}$  and  $\frac{\partial^2 f}{\partial \beta^2}$  are zero on the boundary, the above may be

expressed in terms of  $\frac{\partial^2 f}{\partial \alpha \partial \beta}$  and  $\frac{\partial f}{\partial \alpha}$ .

We may then use checks to see that the centroid of the load,

$$\bar{x} = \frac{\int \int x \sqrt{g} Z_x da d\beta}{\int \int \sqrt{g} Z_x da d\beta} \text{ and similarly for } \bar{y}$$

is the same as that for the boundary loads,

$$\bar{x} = \frac{\oint x \left\{ \frac{\partial Z}{\partial \alpha} N^{\alpha\alpha} + \frac{\partial Z}{\partial \beta} N^{\beta\alpha} \right\} d\beta}{\oint \left\{ \frac{\partial Z}{\partial \alpha} N^{\alpha\alpha} + \frac{\partial Z}{\partial \beta} N^{\beta\alpha} \right\} d\beta}$$

For this we would use the  $x$  and  $y$  as functions of  $\alpha$  and  $\beta$ .

We may also check that the line integrals in the horizontal directions are zero.

Simpson's rule over the same intervals as used for the finite differences is visualized for all these integrations.

### Principal stresses

To find the principal directions of stress in the shell, we have to start from an orthogonal stress matrix with respect to the normal at a given point and then apply an orthogonal transformation which eliminates the shear stress.

Although the surfaces  $x = \text{constant}$  and  $y = \text{constant}$  are orthogonal in the surface  $z = \text{constant}$ , they are not so on the middle surface of the shell.

Probably the simplest starting point is to rotate the  $\alpha$  line to a position at right angles to the  $\beta$  line.

The co-ordinates are all regarded as vertical surfaces. The transformation is obtained by two triangles in the middle surface on a common base.

Thus, to distinguish the transformed stress resultants, we have the  $s$  line coincident with the  $\beta$  line and the orthogonal  $\eta$  line.

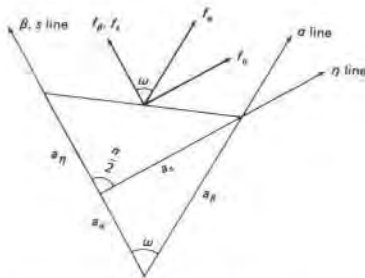

The force and side lengths transformation are

$$\begin{bmatrix} f_\eta \\ f_s \end{bmatrix} = \begin{bmatrix} \sin \omega & \cdot \\ \cos \omega & 1 \end{bmatrix} \begin{bmatrix} f_\alpha \\ f_\beta \end{bmatrix} \quad (49)$$

$$\begin{bmatrix} a_\eta \\ a_s \end{bmatrix} = \begin{bmatrix} 1 & -\cos \omega \\ \cdot & \sin \omega \end{bmatrix} \begin{bmatrix} a_\alpha \\ a_\beta \end{bmatrix}$$

or  $f_\eta = M^* f$  and  $a_\eta = N^* a$  where  $\omega$  is the angle between the  $\alpha, \beta$  lines, on the middle surface.

$$\sin \omega = \frac{\sqrt{g}}{\sqrt{g_\alpha} \sqrt{g_\beta}} \text{ and } \cos \omega = \frac{g_{\alpha\beta}}{\sqrt{g_\alpha} \sqrt{g_\beta}}$$

Since metric components are independent of the cartesian axes, the transformation to the contravariant components is

$$N_\eta = M^* A \ddot{N} B^{-1} N^{*-1} = \frac{1}{\sqrt{g}} K N K^* \text{ since } N = \ddot{N} \sqrt{g}$$

where

$$\text{where } K = M^* A = \begin{bmatrix} \frac{\sqrt{g}}{\sqrt{g_\beta}} & \cdot \\ \frac{g_{\alpha\beta}}{\sqrt{g_\beta}} & \sqrt{g_\beta} \end{bmatrix} \text{ and } K^* = B^{-1} N^{*-1} \quad (50)$$

i.e.  $|K| = \sqrt{g}$

Evidently  $G = K^* K$  and the transformation is,

$$\begin{bmatrix} N_{\eta\eta} & N_{\eta s} \\ N_{s\eta} & N_{ss} \end{bmatrix} = \begin{bmatrix} \frac{\sqrt{g}}{g_\beta} N^{\alpha\alpha} & \frac{g_{\alpha\beta} N^{\alpha\alpha} + N^{\alpha\beta}}{g_\beta} \\ \frac{g_{\alpha\beta} N^{\alpha\alpha} + N^{\alpha\beta}}{g_\beta} & \frac{1}{\sqrt{g}} \left\{ \frac{g^2_{\alpha\beta} N^{\alpha\alpha} + 2g_{\alpha\beta} N^{\alpha\beta} + g_\beta N^{\beta\beta} \right\} \end{bmatrix} \quad (51)$$

The  $\eta$  line is now the tangent to the middle surface perpendicular to the curve where  $\alpha = \text{constant}$  cuts the middle surface.

A further rotation in the tangent plane of the  $(\eta, s)$  lines gives the directions of the principal stresses in the  $(\zeta, \xi)$  lines.

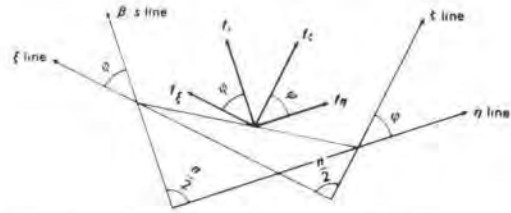

The following well-known operations are set out in a manner suitable for computer work. The principal stress resultants and their directions are obtained by the use of the orthogonal transformation.

$$L^* = L^{-1} = \begin{bmatrix} \cos \varphi & \sin \varphi \\ -\sin \varphi & \cos \varphi \end{bmatrix}$$

$$\text{When } f_\zeta = \{f_\zeta, f_\xi\}, N_\eta = \begin{bmatrix} N_{\eta\eta} & N_{\eta s} \\ N_{\eta s} & N_{ss} \end{bmatrix} \text{ and } N_\zeta = \begin{bmatrix} N_{\zeta\zeta} & \cdot \\ \cdot & N_{\zeta\xi} \end{bmatrix}$$

$$f_\zeta = L^* f_\eta \text{ and } N_\zeta = L^* N_\eta L$$

The shear stress resultants are eliminated when

$$t = \tan 2\varphi = \frac{2N_{\eta s}}{N_{\eta\eta} - N_{ss}} \quad (52)$$

$$\text{or } c = \cot 2\varphi = \frac{N_{\eta\eta} - N_{ss}}{2N_{\eta s}}$$

the latter being more convenient when  $t$  is very large, say,  $> 4$ .

The principal stresses are given by

$$\left. \begin{matrix} N_{\zeta\zeta} \\ N_{\zeta\xi} \end{matrix} \right\} = \frac{1}{2}(N_{\eta\eta} + N_{ss}) \pm \frac{\frac{1}{2}(N_{\eta\eta} - N_{ss}) + tN_{\eta s}}{\sqrt{1+t^2}} \quad (53)$$

or

$$\left. \begin{matrix} N_{\zeta\zeta} \\ N_{\zeta\xi} \end{matrix} \right\} = \frac{1}{2}(N_{\eta\eta} + N_{ss}) \pm \frac{\frac{c}{2}(N_{\eta\eta} - N_{ss}) + N_{\eta s}}{\sqrt{1+c^2}}$$

We shall take  $\varphi$  between the limits

$$-\frac{\pi}{4} \leq \varphi \leq \frac{\pi}{4}$$

so that, in the following, we shall take the lower  $|\text{root}|$  for  $\tan \varphi$ .

$$\therefore \tan \varphi = \frac{\sqrt{1+t^2}-1}{t} = -c \pm \sqrt{1+c^2} \quad \begin{cases} c \text{ positive} \\ c \text{ negative} \end{cases} \quad (54)$$

To plot the directions of principal stresses in plan, we draw lines parallel to the  $\alpha$  and  $\beta$  lines at selected grid points and measure off the intercepts, given

$$\frac{A'X'}{OX'} \text{ and } \frac{B'Y'}{OY'}$$

Vertically below there are corresponding intercepts on the middle surface denoted by  $AX$  and  $BY$ .

The angle  $(\zeta\xi)$  in plan is not a right angle.

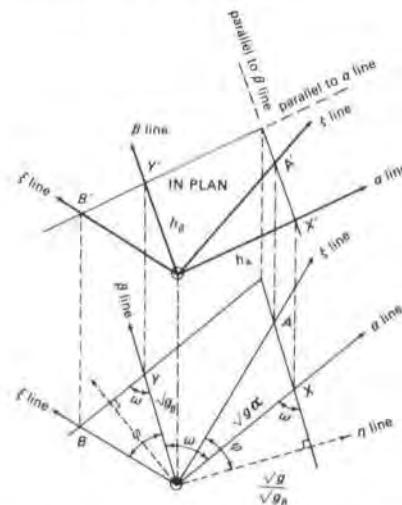

When  $da = d\beta = 1$  the length of the normals to adjacent surfaces are

$$\frac{\sqrt{g}}{\sqrt{g_\beta}} \text{ and } \frac{\sqrt{g}}{\sqrt{g_\alpha}}$$

Then

$$AX = \frac{\sqrt{g}}{\sqrt{g_\beta}} \{ \tan \varphi - \cot \omega \} = \frac{1}{\sqrt{g_\beta}} \{ \sqrt{g} \tan \varphi - g_{a\beta} \}$$

$$\frac{A'X'}{OX'} = \frac{h_\beta}{h_a} \frac{1}{g_\beta} \{ \sqrt{g} \tan \varphi - g_{a\beta} \} \quad (55)$$

$$BY = \frac{\sqrt{g}}{\sqrt{g_a}} \left\{ \tan \left( \varphi + \omega - \frac{\pi}{2} \right) + \cot \omega \right\}$$

now,

$$\tan \left( \varphi + \omega - \frac{\pi}{2} \right) = -\cot(\varphi + \omega) = \frac{\tan \varphi \tan \omega - 1}{\tan \varphi + \tan \omega}$$

$$\tan \left( \varphi + \omega - \frac{\pi}{2} \right) + \cot \omega = \frac{\tan \varphi (\tan \omega + \cot \omega)}{\tan \varphi + \tan \omega}$$

but,

$$\tan \omega + \cot \omega = \frac{\sqrt{g} + g_{a\beta}}{g_{a\beta} \sqrt{g}} = \frac{1}{\sqrt{g} g_{a\beta}} (g + g_{a\beta}^2) = \frac{g_a g_\beta}{\sqrt{g} g_{a\beta}}$$

$$BY = \frac{g_\beta \sqrt{g_a} \tan \varphi}{g_{a\beta} \tan \varphi + \sqrt{g}} = \frac{g_\beta \sqrt{g_a}}{g_{a\beta} + \sqrt{g} \cot \varphi}$$

$$\frac{B'Y'}{OY'} = \frac{h_a g_\beta}{h_\beta (\sqrt{g} \cot \varphi + g_{a\beta})} \quad (56)$$

The principal stress resultants are physical components. When the directions have been plotted, stress trajectories may be sketched.

When the curvilinear co-ordinates are undimensional, say,  $\alpha$  varies from 0 to 1, and  $\beta$  from 0 to  $\pi$ , we may work in undimensional coefficients by

$$\left\{ x y z \right\} = \frac{1}{L} \left\{ X Y Z \right\} \quad (57)$$

when  $\{X Y Z\}$  are physical cartesian co-ordinates, e.g. feet, and  $L$  is a fixed linear dimension in feet.

We then have to put  $\rho = L^2 z_x$  for undimensional loads.

It is seen from page 36, that tensor components have the same dimensions as physical components, and these have to be divided by  $L$  to obtain physical units, say lb/ft.

The computation of the undimensional stress function, with the variable coefficients, will usually be the first program. If the input for the second program is  $f = f/L$ , we shall then obtain stress resultants in physical units.

When the differential equation for  $f$ , where the right-hand side is  $h\rho$ , is put into finite difference form, it may be solved from a large number of linear simultaneous equations. The discriminant of the equations takes the form of a matrix banded in submatrices and may be solved by accumulation processes, as shown in the examples.

Another method is Matrix-Progression, which is particularly appropriate when the shell structure has a line of symmetry.

Use may also be made of the integral equations on page 38.

When  $X_a = 0$  and  $Y_a = 0$ , the first two are satisfied identically leaving the third.

When  $\alpha = \text{constant}$  is a closed curve and  $\beta = 0$ ,  $\pi$  is a line of symmetry:

$$\text{At } \alpha = \text{constant}, \oint_0^\pi \left\{ \frac{\partial z}{\partial \alpha} N^{\alpha\alpha} + \frac{\partial z}{\partial \beta} N^{\alpha\beta} \right\} d\beta = \int_0^\pi \int_0^\alpha \sqrt{g} \rho d\alpha d\beta \quad (58)$$

where the right-hand side is the symmetrical load above the curve,  $\alpha = \text{constant}$ .

This will now be developed in a slightly different notation.

### Integral equations

Let the curvature tensor,  $G_2 = \frac{1}{\sqrt{g}} K$

$$\text{where } k_{ii} = -i_h \frac{\partial^2 x_h}{\partial \alpha_i \partial \alpha_i} \quad (59)$$

$$\Gamma = \begin{bmatrix} \Gamma_{\alpha\alpha}^a & \Gamma_{\alpha\beta}^a & \Gamma_{\beta\beta}^a \\ \Gamma_{\alpha\alpha}^\beta & \Gamma_{\alpha\beta}^\beta & \Gamma_{\beta\beta}^\beta \end{bmatrix} = \begin{bmatrix} \frac{\partial \alpha}{\partial x} & \frac{\partial \alpha}{\partial y} \\ \frac{\partial \beta}{\partial x} & \frac{\partial \beta}{\partial y} \end{bmatrix} \begin{bmatrix} \frac{\partial^2 x}{\partial \alpha^2} & \frac{\partial^2 x}{\partial \alpha \partial \beta} & \frac{\partial^2 x}{\partial \beta^2} \\ \frac{\partial^2 y}{\partial \alpha^2} & \frac{\partial^2 y}{\partial \alpha \partial \beta} & \frac{\partial^2 y}{\partial \beta^2} \end{bmatrix}$$

$$= \frac{1}{h} \begin{bmatrix} \frac{\partial y}{\partial \beta} & -\frac{\partial x}{\partial \beta} \\ -\frac{\partial y}{\partial \alpha} & \frac{\partial x}{\partial \alpha} \end{bmatrix} \begin{bmatrix} \frac{\partial^2 x}{\partial \alpha^2} \\ \text{etc.} \end{bmatrix}$$

$$= \frac{1}{h} \begin{bmatrix} (\alpha, \alpha\alpha) & (\alpha, \alpha\beta) & (\alpha, \beta\beta) \\ (\beta, \alpha\alpha) & (\beta, \alpha\beta) & (\beta, \beta\beta) \end{bmatrix}$$

$$= \frac{1}{h} \begin{bmatrix} \frac{\partial y}{\partial \beta} \frac{\partial^2 x}{\partial \alpha^2} - \frac{\partial x}{\partial \beta} \frac{\partial^2 y}{\partial \alpha^2} & \frac{\partial y}{\partial \beta} \frac{\partial^2 x}{\partial \alpha \partial \beta} - \frac{\partial x}{\partial \beta} \frac{\partial^2 y}{\partial \alpha \partial \beta} & \frac{\partial y}{\partial \beta} \frac{\partial^2 x}{\partial \beta^2} - \frac{\partial x}{\partial \beta} \frac{\partial^2 y}{\partial \beta^2} \\ \frac{\partial x}{\partial \alpha} \frac{\partial^2 y}{\partial \alpha^2} - \frac{\partial y}{\partial \alpha} \frac{\partial^2 x}{\partial \alpha^2} & \frac{\partial x}{\partial \alpha} \frac{\partial^2 y}{\partial \alpha \partial \beta} - \frac{\partial y}{\partial \alpha} \frac{\partial^2 x}{\partial \alpha \partial \beta} & \frac{\partial x}{\partial \alpha} \frac{\partial^2 y}{\partial \beta^2} - \frac{\partial y}{\partial \alpha} \frac{\partial^2 x}{\partial \beta^2} \end{bmatrix} \quad (60)$$

$$\text{where } h = \frac{\partial x}{\partial \alpha} \frac{\partial y}{\partial \beta} - \frac{\partial x}{\partial \beta} \frac{\partial y}{\partial \alpha}$$

$$\text{so that } \frac{\partial h}{\partial \alpha} = (\alpha, \alpha\alpha) + (\beta, \alpha\beta) \quad (61)$$

$$\frac{\partial h}{\partial \beta} = (\beta, \beta\beta) + (\alpha, \alpha\beta)$$

Substituting the stress function in the line integral,

$$\oint \rho \frac{\partial z}{\partial \alpha} \left( \frac{\partial^2 f}{h \partial \beta^2} - \frac{\partial f}{h^2 \partial \alpha} (\alpha, \beta\beta) - \frac{\partial f}{h^2 \partial \beta} (\beta, \beta\beta) \right) d\beta$$

$$+ \oint \rho \frac{\partial z}{\partial \beta} \left( -\frac{\partial^2 f}{h \partial \alpha \partial \beta} + \frac{\partial f}{h^2 \partial \alpha} (\alpha, \alpha\beta) + \frac{\partial f}{h^2 \partial \beta} (\beta, \alpha\beta) \right) d\beta =$$

$$\oint \int_0^\alpha \rho \sqrt{g} \rho d\alpha d\beta$$

now

$$\int \frac{\rho}{h} \frac{\partial z}{\partial \alpha} \frac{d^2 f}{\partial \beta^2} d\beta = - \int \frac{\rho}{h^2} \frac{\partial f}{\partial \beta} \left( h \frac{\partial^2 z}{\partial \alpha \partial \beta} - \frac{\partial z}{\partial \alpha} \frac{\partial h}{\partial \beta} \right) d\beta - \int \frac{1}{h} \frac{\partial \rho}{\partial \beta} \frac{\partial z}{\partial \alpha} \frac{\partial f}{\partial \beta} d\beta$$

and

$$- \int \frac{\rho}{h} \frac{\partial z}{\partial \beta} \frac{\partial^2 f}{\partial \alpha \partial \beta} d\beta = \int \frac{\rho}{h^2} \frac{\partial f}{\partial \alpha} \left( h \frac{\partial^2 z}{\partial \beta^2} - \frac{\partial z}{\partial \beta} \frac{\partial h}{\partial \alpha} \right) d\beta + \int \frac{1}{h} \frac{\partial \rho}{\partial \alpha} \frac{\partial z}{\partial \beta} \frac{\partial f}{\partial \alpha} d\beta$$

Thus the integral becomes

$$\oint \frac{\rho}{h^2} \frac{\partial f}{\partial \alpha} \left( h \frac{\partial^2 z}{\partial \beta^2} - \frac{\partial z}{\partial \alpha} \frac{\partial h}{\partial \beta} \right) d\beta - \oint \frac{\rho}{h^2} \frac{\partial f}{\partial \beta} \left( h \frac{\partial^2 z}{\partial \alpha \partial \beta} - \frac{\partial z}{\partial \alpha} \frac{\partial h}{\partial \beta} \right) d\beta$$

$$+ \oint \frac{1}{h} \frac{\partial \rho}{\partial \beta} \left( \frac{\partial f}{\partial \alpha} \frac{\partial z}{\partial \beta} - \frac{\partial f}{\partial \beta} \frac{\partial z}{\partial \alpha} \right) d\beta = \int \int_0^\alpha \rho \sqrt{g} \rho d\alpha d\beta$$

$$\text{i.e. } \oint \frac{\rho}{h^2} \frac{\partial f}{\partial \alpha} \left( j_1 \frac{\partial^2 z}{\partial \beta^2} + j_2 \frac{\partial^2 y}{\partial \beta^2} + j_3 \frac{\partial^2 z}{\partial \beta^2} \right) d\beta$$

$$- \oint \frac{\rho}{h^2} \frac{\partial f}{\partial \beta} \left( j_1 \frac{\partial^2 x}{\partial \alpha \partial \beta} + j_2 \frac{\partial^2 y}{\partial \alpha \partial \beta} + j_3 \frac{\partial^2 z}{\partial \alpha \partial \beta} \right) d\beta$$

$$+ \oint \frac{1}{h} \frac{\partial \rho}{\partial \beta} \left( \frac{\partial f}{\partial \alpha} \frac{\partial z}{\partial \beta} - \frac{\partial f}{\partial \beta} \frac{\partial z}{\partial \alpha} \right) d\beta = \int \int_0^\alpha \rho \sqrt{g} \rho d\alpha d\beta$$

$$\text{i.e. } \oint \frac{\rho}{h^2} \left( \frac{\partial f}{\partial \beta} k_{\alpha\beta} - \frac{\partial f}{\partial \alpha} k_{\beta\beta} \right) d\beta + \oint \frac{1}{h} \frac{\partial \rho}{\partial \beta} \left( \frac{\partial f}{\partial \alpha} \frac{\partial z}{\partial \beta} - \frac{\partial f}{\partial \beta} \frac{\partial z}{\partial \alpha} \right) d\beta$$

$$= \oint \int_0^\alpha \rho \sqrt{g} \rho d\alpha d\beta$$

$$\text{since } j_1 = \frac{\partial y}{\partial \alpha} \frac{\partial z}{\partial \beta} - \frac{\partial y}{\partial \beta} \frac{\partial z}{\partial \alpha}$$

$$j_2 = \frac{\partial x}{\partial \beta} \frac{\partial z}{\partial \alpha} - \frac{\partial x}{\partial \alpha} \frac{\partial z}{\partial \beta}$$

$$j_3 = h$$

With the variable coefficients the integral equations are converted to summations. When we assume a suitable function for  $f$  with  $3n$  arbitrary constants, we sum on  $n$  values of  $\alpha$ , for the load and the moments of the load and find the constants from  $3n$  simultaneous linear equations.

When  $\beta = 0$ ,  $\pi$  is a line of symmetry and the load is symmetric about



this line the  $2n$  equations have the following form:

At  $\alpha = \text{constant}$ , when  $x = x(\alpha, \beta)$

$$\oint_{\alpha}^{\pi} \frac{x^m}{h^2} \left| \frac{\partial f}{\partial \beta} k_{\alpha\beta} - \frac{\partial f}{\partial \alpha} k_{\beta\beta} \right| d\beta + \oint_{\alpha}^{\pi} \frac{1}{h} \frac{\partial x^m}{\partial \beta} \left| \frac{\partial z}{\partial \beta} \frac{\partial f}{\partial \alpha} - \frac{\partial z}{\partial \alpha} \frac{\partial f}{\partial \beta} \right| d\beta$$

$$= \int_{\alpha}^{\pi} d\beta \int_{\alpha}^x x^m \sqrt{g\rho} da$$

where  $m = 0$  and  $1$ .

If there is no line of symmetry or the loads are not symmetrical, the line integral would have to be complete and moments in both directions would have to be included.

When  $\rho = 1$ ,  $x, y$ , the integral equation becomes

$$\oint_{\alpha}^{2\pi} \frac{\rho}{h^2} \left| \frac{\partial f}{\partial \beta} k_{\alpha\beta} - \frac{\partial f}{\partial \alpha} k_{\beta\beta} \right| d\beta + \oint_{\alpha}^{2\pi} \frac{1}{h} \frac{\partial \rho}{\partial \beta} \left| \frac{\partial z}{\partial \beta} \frac{\partial f}{\partial \alpha} - \frac{\partial z}{\partial \alpha} \frac{\partial f}{\partial \beta} \right| d\beta$$

$$= \oint_{\alpha}^{2\pi} d\beta \int_{\alpha}^x \rho \sqrt{g\rho} da$$

The above demonstrates the alternative definition of normal curvature (see below).

$$K = -h\nabla(z) \left| \nabla^* \right.$$

i.e.

$$k_{ij} = -h \frac{\partial z}{\partial a_i} \left| \frac{\partial^2 z}{\partial a_i \partial a_j} - \frac{\partial z}{\partial a_m} \Gamma_{ij}^m \right| = - \left( h \frac{\partial^2 z}{\partial a_i \partial a_j} - \frac{\partial z}{\partial a_m} \Gamma_{ij}^m \right)$$

### Normal curvature

$$J = \begin{bmatrix} \frac{\partial x}{\partial \alpha} & \frac{\partial x}{\partial \beta} & 1 \\ \frac{\partial y}{\partial \alpha} & \frac{\partial y}{\partial \beta} & m \\ \frac{\partial z}{\partial \alpha} & \frac{\partial z}{\partial \beta} & n \end{bmatrix} \equiv \begin{bmatrix} J_1 & n \end{bmatrix}$$

Cofactors of last column

$$C_1 = \begin{bmatrix} \frac{\partial y}{\partial \alpha} & \frac{\partial y}{\partial \beta} \\ \frac{\partial z}{\partial \alpha} & \frac{\partial z}{\partial \beta} \end{bmatrix} \text{ and } c_1 = \begin{vmatrix} C_1 \end{vmatrix} \text{ does not contain } x$$

$$C_2 = - \begin{bmatrix} \frac{\partial x}{\partial \alpha} & \frac{\partial x}{\partial \beta} \\ \frac{\partial z}{\partial \alpha} & \frac{\partial z}{\partial \beta} \end{bmatrix} \text{ and } c_2 = \begin{vmatrix} C_2 \end{vmatrix} \text{ does not contain } y$$

$$C_3 = \begin{bmatrix} \frac{\partial x}{\partial \alpha} & \frac{\partial x}{\partial \beta} \\ \frac{\partial y}{\partial \alpha} & \frac{\partial y}{\partial \beta} \end{bmatrix} \text{ and } c_3 = \begin{vmatrix} C_3 \end{vmatrix} \text{ does not contain } z$$

when  $n \equiv (n_1, n_2, n_3) \equiv (l, m, n)$

$$\sqrt{a} = [c_1^2 + c_2^2 + c_3^2]^{\frac{1}{2}}$$

$$n = (n_1, n_2, n_3) = \frac{1}{\sqrt{a}} [c_1, c_2, c_3]$$

where metric of middle surface  $A = J_1^* J_1$

When  $(x, y, z)$  are the cartesian co-ordinates of a point on the middle surface  $(\alpha, \beta, \cdot)$ , the co-ordinates at a point at distance  $y$  from the middle surface are  $(x + \gamma l, y + \gamma m, z + \gamma n)$ .

$$\therefore J = J_1 + \gamma J_2$$

$$= [(x) \nabla^* \cdot n] + \gamma (n) \nabla^*$$

where  $\nabla = \left\{ \frac{\partial}{\partial \alpha}, \frac{\partial}{\partial \beta} \right\}$

$$\therefore G = (J_1^* + \gamma J_2^*) (J_1 + \gamma J_2)$$

$$= J_1^* J_1 + \gamma (J_1^* J_2 + J_2^* J_1) + \gamma^2 J_2^* J_2$$

$$= A + 2\gamma B + \gamma^2 B A^{-1} B$$

$$\text{Normal curvature} = \frac{1}{2} \frac{\partial G}{\partial y} = B + \gamma B A^{-1} B$$

If the curvature at  $\gamma$  from the middle surface is significantly different from that of the middle surface, it is better to use three-dimensional analysis. For thin shells we shall take  $B$  as the covariant normal curvature tensor.

Now  $n_k \frac{\partial n_k}{\partial \alpha_i} = 0$ , and since  $n$  is the unit normal vector,

$$n_k \frac{\partial x_k}{\partial \alpha_i} = 0, \text{ i.e. } \frac{\partial x_k}{\partial \alpha_i} \frac{\partial n_k}{\partial \alpha_j} = -n_k \frac{\partial^2 x_k}{\partial \alpha_i \partial \alpha_j}$$

Then  $B = J_1^* J_2 = J_2^* J_1$

$$\therefore b_{ij} = \frac{\partial x_k}{\partial \alpha_i} \frac{\partial n_k}{\partial \alpha_j} = -n_k \frac{\partial^2 x_k}{\partial \alpha_i \partial \alpha_j} = -\frac{c_k}{\sqrt{a}} \frac{\partial^2 x_k}{\partial \alpha_i \partial \alpha_j}$$

$$= -\frac{c_1}{\sqrt{a}} \left\{ \frac{\partial^2 x}{\partial \alpha_i \partial \alpha_j} + \frac{c_2}{c_1} \frac{\partial^2 y}{\partial \alpha_i \partial \alpha_j} + \frac{c_3}{c_1} \frac{\partial^2 z}{\partial \alpha_i \partial \alpha_j} \right\}$$

$$\text{now } C_1^{-1} = \begin{bmatrix} \frac{\partial \alpha}{\partial y} & \frac{\partial \alpha}{\partial z} \\ \frac{\partial \beta}{\partial y} & \frac{\partial \beta}{\partial z} \end{bmatrix} = \frac{1}{c_1} \begin{bmatrix} \frac{\partial z}{\partial \beta} & -\frac{\partial y}{\partial \beta} \\ -\frac{\partial z}{\partial \alpha} & \frac{\partial y}{\partial \alpha} \end{bmatrix}$$

Then another definition of normal curvature,

$$b_{ij} = -\frac{c_1}{\sqrt{a}} \left\{ \frac{\partial^2 x}{\partial \alpha_i \partial \alpha_j} + \frac{1}{c_1} \left( \frac{\partial x}{\partial \beta} \frac{\partial z}{\partial \alpha} - \frac{\partial x}{\partial \alpha} \frac{\partial z}{\partial \beta} \right) \frac{\partial^2 y}{\partial \alpha_i \partial \alpha_j} \right.$$

$$\left. + \frac{1}{c_1} \left( \frac{\partial x}{\partial \alpha} \frac{\partial y}{\partial \beta} - \frac{\partial x}{\partial \beta} \frac{\partial y}{\partial \alpha} \right) \frac{\partial^2 z}{\partial \alpha_i \partial \alpha_j} \right\}$$

$$= -\frac{c_1}{\sqrt{a}} \left\{ \frac{\partial^2 x}{\partial \alpha_i \partial \alpha_j} - \left( \frac{\partial x}{\partial \alpha} \frac{\partial \alpha}{\partial y} + \frac{\partial x}{\partial \beta} \frac{\partial \beta}{\partial y} \right) \frac{\partial^2 y}{\partial \alpha_i \partial \alpha_j} \right.$$

$$\left. - \left( \frac{\partial x}{\partial \alpha} \frac{\partial \alpha}{\partial z} + \frac{\partial x}{\partial \beta} \frac{\partial \beta}{\partial z} \right) \frac{\partial^2 z}{\partial \alpha_i \partial \alpha_j} \right\}$$

$$= -\frac{c_1}{\sqrt{a}} \left\{ \frac{\partial^2 x}{\partial \alpha_i \partial \alpha_j} - \frac{\partial x}{\partial a_m} \Gamma_{ij}^m \right\}$$

$$= -\frac{c_1}{\sqrt{a}} \frac{\partial x}{\partial \alpha_i} \left| \Gamma \right. \text{ when } \Gamma \text{ does not contain } x$$

In general,

$$b_{ij} = -\frac{c_p}{\sqrt{a}} \frac{\partial x_p}{\partial \alpha_i} \left| \Gamma \right. \text{ where } x_p \text{ is treated as a dependent variable.}$$

The contravariant metric naturally brings in the contravariant components of curvature, which are the curvature tensor of lines normal to the co-ordinate lines.

$$G = A(I + 2\lambda A^{-1} B + \lambda^2 A^{-1} B A^{-1} B)$$

$$\therefore G^{-1} = (I - 2\lambda A^{-1} B + 3\lambda^2 A^{-1} B A^{-1} B - \dots) A^{-1}$$

$$= A^{-1} - 2\lambda B + 3\lambda^2 B \cdot B - \dots$$

$$\text{or } g^{ij} = a^{ij} - 2\lambda b^{ij} + 3\lambda^2 b^{im} b_m^j - \dots$$

where in thin shells terms after the second are neglected.

### Direct treatment of boundary conditions

On plane  $z = \text{constant}$ ,

$$H = \begin{bmatrix} \frac{\partial x}{\partial \alpha} & \frac{\partial x}{\partial \beta} \\ \frac{\partial y}{\partial \alpha} & \frac{\partial y}{\partial \beta} \end{bmatrix} \quad H^{-1} = \frac{1}{h} \begin{bmatrix} \frac{\partial y}{\partial \beta} & -\frac{\partial x}{\partial \beta} \\ -\frac{\partial y}{\partial \alpha} & \frac{\partial x}{\partial \alpha} \end{bmatrix}$$

$$A_\alpha = H^* H = \begin{bmatrix} h_a^2 & h_{a\beta} \\ h_{a\beta} & h_\beta^2 \end{bmatrix} \quad A_\alpha^{-1} = \frac{1}{h^2} \begin{bmatrix} h_\beta^2 & -h_{a\beta} \\ -h_{a\beta} & h_a^2 \end{bmatrix}$$

$$D_1 = \begin{bmatrix} h_a & \\ & h_\beta \end{bmatrix} \quad D_2 = \frac{1}{h} \begin{bmatrix} h_\beta & \\ & h_a \end{bmatrix}$$

Direction cosines of plan projection of co-ordinate lines and normals to co-ordinate lines,

$$M = D_1^{-1} H^* = \begin{bmatrix} l_a & m_a \\ l_\beta & m_\beta \end{bmatrix} = \begin{bmatrix} \frac{1}{h_a} & \\ & \frac{1}{h_\beta} \end{bmatrix} \begin{bmatrix} \frac{\partial x}{\partial \alpha} & \frac{\partial y}{\partial \alpha} \\ \frac{\partial x}{\partial \beta} & \frac{\partial y}{\partial \beta} \end{bmatrix}$$

$$N = D_2^{-1}H^{-1} = \begin{bmatrix} L_\alpha & M_\alpha \\ L_\beta & M_\beta \end{bmatrix} = \begin{bmatrix} \frac{1}{h_\beta} & \\ & \frac{1}{h_\alpha} \end{bmatrix} \begin{bmatrix} \frac{\partial y}{\partial \beta} & -\frac{\partial x}{\partial \beta} \\ -\frac{\partial y}{\partial \alpha} & \frac{\partial x}{\partial \alpha} \end{bmatrix}$$

Physical curvatures of plan projection of  $\alpha$  line and  $\beta$  line,  $1/R_\alpha$  and  $1/R_\beta$  respectively.

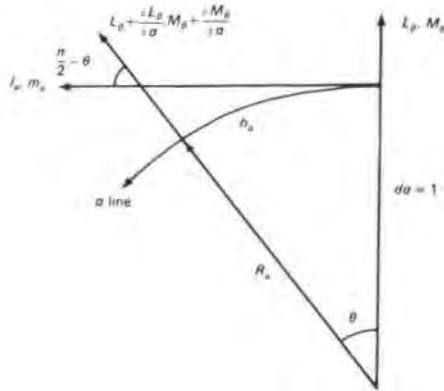

$$\cos\left(\frac{\pi}{2} - \theta\right) = \sin \theta = \theta = \frac{h_\alpha}{R_\alpha} = l_\alpha \left( L_\beta + \frac{\partial L_\beta}{\partial \alpha} \right) + m_\alpha \left( M_\beta + \frac{\partial M_\beta}{\partial \alpha} \right)$$

$$\frac{1}{R_\alpha} = \frac{1}{h_\alpha^2} \left( \frac{\partial x}{\partial \alpha} \frac{\partial}{\partial \alpha} \left( -\frac{\partial y}{h_\alpha \partial \alpha} \right) + \frac{\partial y}{\partial \alpha} \frac{\partial}{\partial \alpha} \left( \frac{\partial x}{h_\alpha \partial \alpha} \right) \right)$$

$$= \frac{1}{h_\alpha^3} \left( -\frac{\partial x}{\partial \alpha} \frac{\partial^2 y}{\partial \alpha^2} + \frac{\partial y}{\partial \alpha} \frac{\partial^2 x}{\partial \alpha^2} \right) = -\frac{(\beta, \alpha\alpha)}{h_\alpha^3} = \frac{\frac{\partial y}{\partial \alpha} \frac{\partial^2 x}{\partial \alpha^2} - \frac{\partial x}{\partial \alpha} \frac{\partial^2 y}{\partial \alpha^2}}{\left( \left( \frac{\partial x}{\partial \alpha} \right)^2 + \left( \frac{\partial y}{\partial \alpha} \right)^2 \right)^{3/2}}$$

Similarly,

$$\frac{1}{R_\beta} = -\frac{(\alpha, \beta\beta)}{h_\beta^3} = \frac{\frac{\partial x}{\partial \beta} \frac{\partial^2 y}{\partial \beta^2} - \frac{\partial y}{\partial \beta} \frac{\partial^2 x}{\partial \beta^2}}{\left( \left( \frac{\partial x}{\partial \beta} \right)^2 + \left( \frac{\partial y}{\partial \beta} \right)^2 \right)^{3/2}}$$

When boundary is on  $\alpha = \text{constant}$

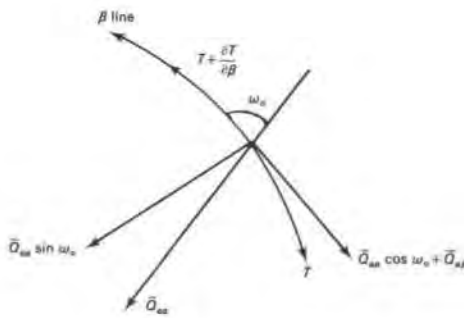

$$\text{normal component of } \bar{Q}_{\alpha\alpha} = \bar{Q}_{\alpha\alpha} \frac{h}{h_\alpha h_\beta} = \frac{h}{h_\beta^2} N^{\alpha\alpha}$$

$$\text{tangential component} = \bar{Q}_{\alpha\alpha} \frac{h^2 a_{\alpha\beta}}{h_\alpha h_\beta} + \bar{Q}_{\alpha\beta} = \frac{h^2 a_{\alpha\beta}}{h_\beta^2} N^{\alpha\alpha} + N^{\alpha\beta}$$

These are the horizontal orthogonal stresses, corresponding to (51).

$$\text{On the boundary, } N^{\alpha\alpha} = -\frac{(\alpha, \beta\beta)}{h^2} \frac{\partial f}{\partial \alpha}$$

$$N^{\alpha\beta} = -\frac{\partial^2 f}{h \partial \alpha \partial \beta} + \frac{(\alpha, \alpha\beta)}{h^2} \frac{\partial f}{\partial \alpha}$$

$$T = -\frac{h}{h_\beta^2} N^{\alpha\alpha} R_\beta = -\frac{h_\beta}{h} \frac{\partial f}{\partial \alpha}$$

$$\text{Now } \frac{\partial T}{\partial \beta} = h_\beta (\bar{Q}_{\alpha\alpha} \cos \omega_\alpha + \bar{Q}_{\alpha\beta})$$

$$= -\frac{h^2 a_{\alpha\beta}}{h_\beta} \frac{(\alpha, \beta\beta)}{h^2} \frac{\partial f}{\partial \alpha} - \frac{h_\beta}{h} \frac{\partial^2 f}{\partial \alpha \partial \beta} + \frac{h_\beta}{h^2} (\alpha, \alpha\beta) \frac{\partial f}{\partial \alpha}$$

This is identical with

$$\frac{\partial T}{\partial \beta} = -\frac{\partial}{\partial \beta} \left( \frac{h_\beta}{h} \frac{\partial f}{\partial \alpha} \right) - \frac{h_\beta}{h} \frac{\partial^2 f}{\partial \alpha \partial \beta} + \frac{h_\beta}{h^2} \frac{\partial f}{\partial \alpha} \frac{\partial h}{\partial \beta} - \frac{1}{h} \frac{\partial f}{\partial \alpha} \frac{\partial h_\beta}{\partial \beta}$$

$$\text{now } \frac{1}{\sqrt{g}} \frac{\partial \sqrt{g}}{\partial \alpha_n} = \Gamma_{mn}^m \text{ or } \frac{\partial h}{\partial \beta} = (\alpha, \alpha\beta) + (\beta, \beta\beta)$$

and

$$\frac{\partial g_{ik}}{\partial \alpha_n} = g_{mk} \Gamma_{in}^m + g_{im} \Gamma_{kn}^m$$

$$\text{or } \frac{1}{2} \frac{\partial h^2_{\beta\beta}}{\partial \beta} = h_{\beta\beta} \frac{\partial h_{\beta\beta}}{\partial \beta} = h^2_{\alpha\beta} \frac{(\alpha, \beta\beta)}{h} + h^2_{\beta\beta} \frac{(\beta, \beta\beta)}{h}$$

so that the expression becomes, to show the identity,

$$-\frac{h_\beta}{h} \frac{\partial^2 f}{\partial \alpha \partial \beta} + \frac{1}{h^2} \left( h_\beta (\alpha, \alpha\beta) + h_\beta (\beta, \beta\beta) - \frac{h^2_{\alpha\beta} (\alpha, \beta\beta)}{h_\beta} - \frac{h^2_{\beta\beta} (\beta, \beta\beta)}{h_\beta} \right) \frac{\partial f}{\partial \alpha}$$

$$= -\frac{h_\beta}{h} \frac{\partial^2 f}{\partial \alpha \partial \beta} + \frac{h_\beta}{h^2} (\alpha, \alpha\beta) \frac{\partial f}{\partial \alpha} - \frac{h^2_{\alpha\beta} (\alpha, \beta\beta)}{h^2 h_\beta} \frac{\partial f}{\partial \alpha}$$

When the boundary is not in a horizontal plane,

$$T = -\frac{\sqrt{g_\beta}}{h} \frac{\partial f}{\partial \alpha}$$

since the first expression gives the horizontal component of boundary tension.

### Principal curvatures

The diagonal matrices formerly called  $A$  and  $B$  will now be denoted by  $D_1$  and  $D_2$ .

$A$  is now the metric tensor of the middle surface and  $B$  the covariant curvature tensor, so that

$$G = A + 2\lambda B \text{ or } B = \frac{1}{2} \frac{\partial G}{\partial \lambda}$$

and  $D_1 = \text{Diag. } [\sqrt{a_{ii}}]$ ,  $D_2 = \text{Diag. } [\sqrt{a''}]$  not summed.

When  $H$  denotes a two by two transformation to a pair of orthogonal directions on the middle surface, defined as in my 'Arch Dams' (p. 78) by

$$f\eta = H^* f$$

the physical curvatures in the orthogonal lines are related by

$$\bar{B} = HB\eta H^* = D_1^{-1} K^* B_\eta K D_1^{-1} = D_1^{-1} B D_1^{-1}$$

where  $K$  is a two by two matrix taking the place of  $J$ .

The principal curvatures are the roots of

$$|\lambda I - B_\eta| = 0$$

$$\text{i.e. } |\lambda I - K^* B K^{-1}| = 0$$

$$\text{i.e. } |\lambda A - B| = 0 \text{ since } A = K^* K$$

in expanded form

$$\lambda^2 a - \lambda(a_{\alpha\alpha} b_{\beta\beta} - 2a_{\alpha\beta} b_{\alpha\beta} + a_{\beta\beta} b_{\alpha\alpha}) + b = 0$$

where  $a = |A|$  and  $b = |B|$

$$\text{i.e. } \lambda^2 - \lambda A^{-1} \cdot B + \frac{b}{a} = 0$$

which is the reverse of the equation on p. 72 of my 'Arch Dams' paper.

If we define curvature by

$$B = \frac{1}{\sqrt{a}} K \text{ (the other meaning)}$$

and

$$k = |K|$$

we have

$$(\lambda a)^2 - (\lambda a) \frac{a_{\alpha\alpha} k_{\beta\beta} - 2a_{\alpha\beta} k_{\alpha\beta} + a_{\beta\beta} k_{\alpha\alpha}}{\sqrt{a}} + k = 0$$

hence  $\lambda a$ ,  $\lambda$  and hence the radii,

$$r_1 = \frac{L}{\lambda_1}, r_2 = \frac{L}{\lambda_2}$$

where  $L$  is the dimensionalizing constant for  $x$ ,  $y$  and  $z$ .

An alternative derivation may be informative.

The covariant curvature tensor has been defined by

$$B = [b_{ij}] \text{ where } b_{ij} = -n_k \frac{\partial^2 x_k}{\partial \alpha_i \partial \alpha_j}$$

In the surface co-ordinates  $n = \{ \dots, 1 \}$  and the orthogonal curvatures are

$$B_\eta = -\nabla_\eta \nabla_\eta^* (\gamma)$$

now

$$\nabla = K^* \nabla_\eta$$

so that

$$B_\eta = -K^* \nabla \nabla^* K^{-1} (\gamma) = K^* \nabla B K^{-1}$$

since the  $\partial \gamma / \partial \alpha_m = 0$ .

If we require to know the principal directions we have to proceed from the orthogonal directions as for principal stresses.

## Curvature tensors

### (I) Co-ordinate lines

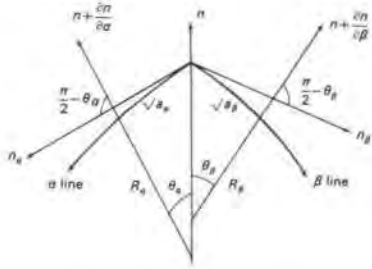

$$\cos\left(\frac{\pi}{2} - \theta_a\right) = \theta_a = \frac{\partial n}{\partial \alpha} n_a^*$$

$$\frac{1}{R_a} = \frac{\theta_a}{\sqrt{a_a}} = \frac{1}{\sqrt{a_a}} \frac{\partial n}{\partial \alpha} n_a^*$$

Rotation of normal in moving from  $(\alpha, \beta)$  to  $(\alpha + d\alpha, \beta + d\beta)$

$$\frac{1}{R_\beta} = \frac{1}{\sqrt{a_\beta}} \frac{\partial n}{\partial \beta} n_\beta^*$$

$$\frac{1}{R_{a\beta}} = \frac{1}{\sqrt{a_a}} \frac{\partial n}{\partial \alpha} n_\beta^* = \frac{1}{\sqrt{a_\beta}} \frac{\partial n}{\partial \beta} n_a^*$$

$$\therefore \begin{bmatrix} \frac{1}{R_a} & \frac{1}{R_{a\beta}} \\ \frac{1}{R_{a\beta}} & \frac{1}{R_\beta} \end{bmatrix} = D_1^{-1} \nabla(n^*) M^* = D_1^{-1} \nabla(n^*) J D_1^{-1} = D_1^{-1} \beta D_1^{-1}$$

Covariant tensor,

$$\beta = \nabla(n^*) J_1 = J_2^* J_1$$

$$\text{or } b_{ij} = \frac{\partial n_k}{\partial \alpha_i} \frac{\partial x_k}{\partial \alpha_j} = -n_k \frac{\partial^2 x_k}{\partial \alpha_i \partial \alpha_j} = \frac{-j_k}{\sqrt{a}} \frac{\partial^2 x_k}{\partial \alpha_i \partial \alpha_j}$$

### (II) Normals to co-ordinate lines

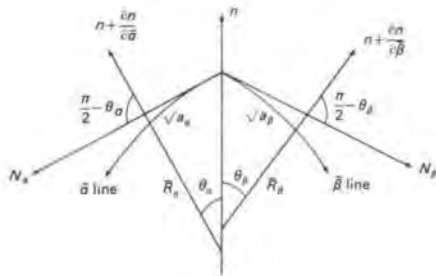

$$\cos\left(\frac{\pi}{2} - \theta_a\right) = \frac{\partial n}{\partial \alpha} N_a^* = \theta_a$$

$$\frac{1}{R_a} = \frac{1}{\sqrt{a^x}} \frac{\partial n}{\partial \alpha} N_a^*$$

$$\frac{1}{R_\beta} = \frac{1}{\sqrt{a^\beta}} \frac{\partial n}{\partial \beta} N_\beta^*$$

$$\frac{1}{R_{a\beta}} = \frac{1}{\sqrt{a^x}} \frac{\partial n}{\partial \alpha} N_\beta^* = \frac{1}{\sqrt{a^\beta}} \frac{\partial n}{\partial \beta} N_a^*$$

$\therefore$  Physical curvatures =

$$D_2^{-1} \bar{\nabla}(n^*) N^* = D_2^{-1} \bar{\nabla}(n^*) J^{*-1} D_2^{-1} = D_2^{-1} \beta D_2^{-1}$$

now

$$\bar{\nabla} = A^{-1} \nabla \text{ and } J^{*-1} = J A^{-1}$$

$\therefore$

$$\text{Tensor } B = A^{-1} \nabla(n^*) J A^{-1} = A^{-1} \beta A^{-1}$$

i.e.

$$b^{ij} = a^{ir} b_{rs} a^{sj}$$

### (III) Co-ordinate lines in relation to normal lines

$$\text{Physical curvature} = D_1^{-1} \nabla(n^*) N^* = D_1^{-1} \nabla(n^*) J^{*-1} D_2^{-1} = D_1^{-1} \nabla(n^*) J A^{-1} D_2^{-1} = D_1^{-1} \beta A^{-1} D_2^{-1}$$

Thus,

$$\beta = \beta A^{-1}$$

i.e.

$$b'_i = b_{ij} a^{ji}$$

### (IV) Normal lines in relation to co-ordinate lines

Physical =

$$D_2^{-1} \bar{\nabla}(n^*) M^* = D_2^{-1} A^{-1} \nabla(n^*) J D_1^{-1} = D_2^{-1} A^{-1} \beta D_1^{-1}$$

Thus,

$$\beta = A^{-1} \beta$$

i.e.

$$b'_j = a^{ir} b_{ri} \text{ where } \beta = (\beta)^*$$

We now have physical meaning for all four kinds of curvature tensors.

We also note that

$$D_1 = \begin{bmatrix} \sqrt{a_a} & & \\ & \sqrt{a_\beta} & \\ & & \sqrt{a^\beta} \end{bmatrix} \text{ and } D_2 = \begin{bmatrix} \sqrt{a^x} & & \\ & \sqrt{a_\beta} & \\ & & \sqrt{a_a} \end{bmatrix} = \frac{1}{\sqrt{a}} \begin{bmatrix} \sqrt{a_\beta} & & \\ & \sqrt{a_\beta} & \\ & & \sqrt{a_a} \end{bmatrix}$$

$\bar{\nabla}$  is a contravariant operator.

Let the  $\eta$  line denote the normal to the  $\beta$  line, and the  $s$  line be coincident with the  $\beta$  line.

If we then find the physical normal curvature of the  $\eta$  line (II), the mixed twist of the  $\eta$  and  $s$  lines (III), and the curvature of the  $s$  line (I), it is easily shown that this set of orthogonal physical curvatures is

$$C_\eta = \kappa^{*-1} \beta \kappa^{-1} = \begin{bmatrix} \frac{\sqrt{a_\beta}}{\sqrt{a}} & -\frac{a_{a\beta}}{\sqrt{a}\sqrt{a_\beta}} \\ & \frac{1}{\sqrt{a_\beta}} \end{bmatrix} \begin{bmatrix} b_{aa} & b_{a\beta} \\ b_{a\beta} & b_{\beta\beta} \end{bmatrix} \begin{bmatrix} \frac{\sqrt{a_\beta}}{\sqrt{a}} & \\ -\frac{a_{a\beta}}{\sqrt{a}\sqrt{a_\beta}} & \frac{1}{\sqrt{a_\beta}} \end{bmatrix}$$

$$\text{so that } \kappa = \begin{bmatrix} \frac{\sqrt{a}}{\sqrt{a_\beta}} & \\ \frac{a_{a\beta}}{\sqrt{a_\beta}} & \sqrt{a_\beta} \end{bmatrix}$$

i.e.

$$|\kappa| = \sqrt{a} \text{ and } A = \kappa^* \kappa$$

It has been shown that we do not have to find the orthogonal curvatures to obtain the principal physical curvatures, but only for the principal directions.

